

NCS20071, NCV20071, NCS20072, NCV20072, NCS20074, NCV20074



ON Semiconductor®

www.onsemi.com

Operational Amplifier, Rail-to-Rail Output, 3 MHz BW

The NCx2007x series operational amplifiers provide rail-to-rail output operation, 3 MHz bandwidth, and are available in single, dual, and quad configurations. Rail-to-rail operation enables the user to make optimal use of the entire supply voltage range while taking advantage of 3 MHz bandwidth. The NCx2007x can operate on supply voltages as low as 2.7 V over the temperature range of -40°C to 125°C . At a 2.7 V supply, the high bandwidth provides a slew rate of $2.8\text{ V}/\mu\text{s}$ while only consuming $405\ \mu\text{A}$ of quiescent current per channel. The wide supply range allows the NCx2007x to run on supply voltages as high as 36 V, making it ideal for a broad range of applications. Since this is a CMOS device, high input impedance and low bias currents make it ideal for interfacing to a wide variety of signal sensors. The NCx2007x devices are available in a variety of compact packages. Automotive qualified options are available under the NCV prefix.

Features

- Rail-To-Rail Output
- Wide Supply Range: 2.7 V to 36 V
- Wide Bandwidth: 3 MHz typical at $V_S = 2.7\text{ V}$
- High Slew Rate: $2.8\text{ V}/\mu\text{s}$ typical at $V_S = 2.7\text{ V}$
- Low Supply Current: $405\ \mu\text{A}$ per channel at $V_S = 2.7\text{ V}$
- Low Input Bias Current: 5 pA typical
- Wide Temperature Range: -40°C to 125°C
- Available in a variety of packages
- NCV Prefix for Automotive and Other Applications Requiring Unique Site and Control Change Requirements; AEC-Q100 Qualified and PPAP Capable
- These Devices are Pb-Free, Halogen Free/BFR Free and are RoHS Compliant

Applications

- Current Sensing
- Signal Conditioning
- Automotive

End Products

- Notebook Computers
- Portable Instruments
- Power Supplies



SOT-553
CASE 463B



TSOP-5
CASE 483



Micro8™
CASE 846A



SOIC-8
CASE 751

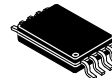

TSSOP-8
CASE 948S

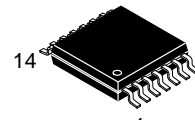

TSSOP-14
CASE 948G

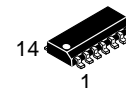

SOIC-14 NB
CASE 751A

DEVICE MARKING INFORMATION

See general marking information in the device marking section on page 2 of this data sheet.

ORDERING INFORMATION

See detailed ordering and shipping information on page 4 of this data sheet.

MARKING DIAGRAMS

Single Channel Configuration
NCS20071, NCV20071



SOT-553
CASE 463B

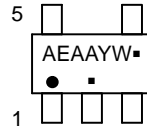

TSOP-5
CASE 483

Dual Channel Configuration
NCS20072, NCV20072



Micro8™
CASE 846A



SOIC-8
CASE 751

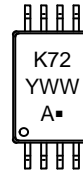

TSSOP-8
CASE 948S

Quad Channel Configuration
NCS20074, NCV20074

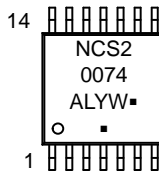

TSSOP-14
CASE 948G



SOIC-14 NB
CASE 751A

- XXXXX = Specific Device Code
- A = Assembly Location
- WL, L = Wafer Lot
- Y = Year
- WW, W = Work Week
- G or ■ = Pb-Free Package

(Note: Microdot may be in either location)

NCS20071, NCV20071, NCS20072, NCV20072, NCS20074, NCV20074

Single Channel Configuration
NCS20071, NCV20071



Dual Channel Configuration
NCS20072, NCV20072



Quadruple Channel Configuration
NCS20074, NCV20074

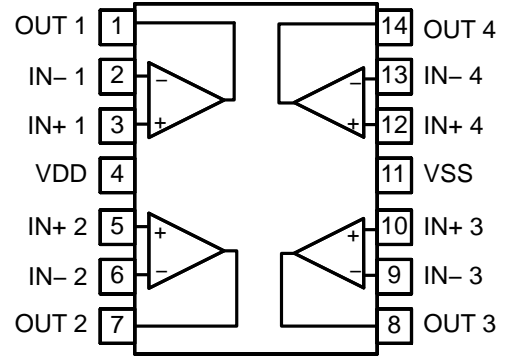

Figure 1. Pin Connections

NCS20071, NCV20071, NCS20072, NCV20072, NCS20074, NCV20074

ORDERING INFORMATION

Device	Configuration	Automotive	Marking	Package	Shipping†
NCS20071SN2T1G	Single	No	AEA	TSOP-5 (Pb-Free)	3000 / Tape and Reel
NCS20071XV53T2G			AL	SOT553-5 (Pb-Free)	4000 / Tape and Reel
NCV20071SN2T1G*		Yes	AEA	TSOP-5 (Pb-Free)	3000 / Tape and Reel
NCV20071XV53T2G*			AL	SOT553-5 (Pb-Free)	4000 / Tape and Reel
NCS20072DMR2G	Dual	No	0072	Micro8 (MSOP8) (Pb-Free)	4000 / Tape and Reel
NCS20072DR2G			NCS20072	SOIC-8 (Pb-Free)	2500 / Tape and Reel
NCS20072DTBR2G			K72	TSSOP-8 (Pb-Free)	2500 / Tape and Reel
NCV20072DMR2G*		Yes	0072	Micro8 (MSOP8) (Pb-Free)	4000 / Tape and Reel
NCV20072DR2G*			NCS20072	SOIC-8 (Pb-Free)	2500 / Tape and Reel
NCV20072DTBR2G*			K72	TSSOP-8 (Pb-Free)	2500 / Tape and Reel
NCS20074DR2G	Quad	No	NCS20074	SOIC-14 (Pb-Free)	2500 / Tape and Reel
NCS20074DTBR2G			NCS2 0074	TSSOP-14 (Pb-Free)	2500 / Tape and Reel
NCV20074DR2G*		Yes	NCS20074	SOIC-14 (Pb-Free)	2500 / Tape and Reel
NCV20074DTBR2G*			NCS2 0074	TSSOP-14 (Pb-Free)	2500 / Tape and Reel

†For information on tape and reel specifications, including part orientation and tape sizes, please refer to our Tape and Reel Packaging Specifications Brochure, BRD8011/D.

*NCV Prefix for Automotive and Other Applications Requiring Unique Site and Control Change Requirements; AEC-Q100 Qualified and PPAP Capable.

NCS20071, NCV20071, NCS20072, NCV20072, NCS20074, NCV20074

ABSOLUTE MAXIMUM RATINGS (Note 1)

Rating	Symbol	Limit	Unit	
Supply Voltage ($V_{DD} - V_{SS}$) (Note 4)	V_S	40	V	
Input Voltage	V_{CM}	$V_{SS} - 0.2$ to $V_{DD} + 0.2$	V	
Differential Input Voltage (Note 2)	V_{ID}	$\pm V_S$	V	
Maximum Input Current	I_{IN}	± 10	mA	
Maximum Output Current (Note 3)	I_O	± 100	mA	
Continuous Total Power Dissipation (Note 4)	P_D	200	mW	
Maximum Junction Temperature	T_J	150	°C	
Storage Temperature Range	T_{STG}	-65 to 150	°C	
Mounting Temperature (Infrared or Convection – 20 sec)	T_{mount}	260	°C	
ESD Capability (Note 5)	Human Body Model	HBM	2000	V
	Machine Model – NCx20071	MM	200	
	Machine Model – NCx20072, NCx20074	MM	150	
	Charged Device Model – NCx20071, NCx20072	CDM	2000 (C6)	
	Charged Device Model – NCx20074	CDM	1000 (C6)	
Latch-Up Current (Note 6)	I_{LU}	100	mA	
Moisture Sensitivity Level (Note 7)	MSL	Level 1		

Stresses exceeding those listed in the Maximum Ratings table may damage the device. If any of these limits are exceeded, device functionality should not be assumed, damage may occur and reliability may be affected.

- Refer to ELECTRICAL CHARACTERISTICS and APPLICATION INFORMATION for Safe Operating Area.
- Maximum input current must be limited to ± 10 mA. Series connected resistors of at least 500 Ω on both inputs may be used to limit the maximum input current to ± 10 mA.
- Total power dissipation must be limited to prevent the junction temperature from exceeding the 150°C limit.
- Continuous short circuit operation to ground at elevated ambient temperature can result in exceeding the maximum allowed junction temperature of 150°C. Output currents in excess of the maximum output current rating over the long term may adversely affect reliability. Shorting output to either VDD or VSS will adversely affect reliability.
- This device series incorporates ESD protection and is tested by the following methods:
 ESD Human Body Model tested per JEDEC standard JS-001 (AEC-Q100-002)
 ESD Machine Model tested per JEDEC standard JESD22-A115 (AEC-Q100-003)
 ESD Charged Device Model tested per JEDEC standard JESD22-C101 (AEC-Q100-011)
- Latch-up Current tested per JEDEC standard JESD78 (AEC-Q100-004)
- Moisture Sensitivity Level tested per IPC/JEDEC standard J-STD-020A

THERMAL INFORMATION

Parameter	Symbol	Package	Single Layer Board (Note 8)	Multi-Layer Board (Note 9)	Unit
Junction-to-Ambient	θ_{JA}	SOT23-5 / TSOP5	265	195	°C/W
		SOT553-5	325	244	
		Micro8 / MSOP8	236	167	
		SOIC-8	190	131	
		TSSOP-8	253	194	
		SOIC-14	142	101	
		TSSOP-14	179	128	

8. Values based on a 1S standard PCB according to JEDEC51-3 with 1.0 oz copper and a 300 mm² copper area

9. Values based on a 1S2P standard PCB according to JEDEC51-7 with 1.0 oz copper and a 100 mm² copper area

OPERATING RANGES

Parameter	Symbol	Min	Max	Unit
Operating Supply Voltage (Single Supply)	V_S	2.7	36	V
Operating Supply Voltage (Split Supply)	V_S	± 1.35	± 18	V
Differential Input Voltage (Note 10)	V_{ID}		V_S	V
Input Common Mode Voltage Range	V_{CM}	V_{SS}	$V_{DD} - 1.35$	V
Ambient Temperature	T_A	-40	125	°C

Functional operation above the stresses listed in the Recommended Operating Ranges is not implied. Extended exposure to stresses beyond the Recommended Operating Ranges limits may affect device reliability.

- Maximum input current must be limited to ± 10 mA. See Absolute Maximum Ratings for more information.

NCS20071, NCV20071, NCS20072, NCV20072, NCS20074, NCV20074

ELECTRICAL CHARACTERISTICS AT $V_S = 2.7\text{ V}$

$T_A = 25^\circ\text{C}$; $R_L \geq 10\text{ k}\Omega$; $V_{CM} = V_{OUT} = \text{mid-supply}$ unless otherwise noted. All limits are guaranteed by testing or statistical analysis.

Boldface limits apply over the specified temperature range, $T_A = -40^\circ\text{C}$ to 125°C . (Notes 11, 12)

Parameter	Symbol	Conditions	Min	Typ	Max	Unit	
INPUT CHARACTERISTICS							
Input Offset Voltage	V_{OS}	NCx20071			1.3	± 3.5	mV
						± 4.5	
		NCx20072, NCx20074			1.3	± 3	
					± 4		
Offset Voltage Drift	$\Delta V_{OS}/\Delta T$	$T_A = 25^\circ\text{C}$ to 125°C			2		$\mu\text{V}/^\circ\text{C}$
Input Bias Current (Note 12)	I_{IB}				5	200	pA
						1500	
Input Offset Current (Note 12)	I_{OS}	NCx20071, NCx20072			2	75	pA
						500	
		NCx20074			2	75	
						200	
Channel Separation	XTLK	DC	NCx20072		100		dB
			NCx20074		115		
Differential Input Resistance	R_{ID}				5		$\text{G}\Omega$
Common Mode Input Resistance	R_{IN}				5		$\text{G}\Omega$
Differential Input Capacitance	C_{ID}				1.5		pF
Common Mode Input Capacitance	C_{CM}				3.5		pF
Common Mode Rejection Ratio	CMRR	$V_{CM} = V_{SS} + 0.2\text{ V}$ to $V_{DD} - 1.35\text{ V}$			90	110	dB
					69		

OUTPUT CHARACTERISTICS

Open Loop Voltage Gain	A_{VOL}			96	118		dB
				86			
Output Current Capability (Note 13)	I_O	Op amp sinking current			70		mA
		Op amp sourcing current			50		
Output Voltage High	V_{OH}	Voltage output swing from positive rail			0.006	0.15	V
						0.22	
Output Voltage Low	V_{OL}	Voltage output swing from negative rail			0.005	0.15	V
						0.22	

AC CHARACTERISTICS

Unity Gain Bandwidth	UGBW	$C_L = 25\text{ pF}$			3		MHz
Slew Rate at Unity Gain	SR	$C_L = 20\text{ pF}$, $R_L = 2\text{ k}\Omega$			2.8		$\text{V}/\mu\text{s}$
Phase Margin	φ_m	$C_L = 25\text{ pF}$			50		$^\circ$
Gain Margin	A_m	$C_L = 25\text{ pF}$			14		dB
Settling Time	t_s	$V_O = 1\text{ V}_{pp}$, Gain = 1, $C_L = 20\text{ pF}$		Settling time to 0.1%	0.6		μs
				Settling time to 0.01%	1.2		

Product parametric performance is indicated in the Electrical Characteristics for the listed test conditions, unless otherwise noted. Product performance may not be indicated by the Electrical Characteristics if operated under different conditions.

11. Refer to ABSOLUTE MAXIMUM RATINGS and APPLICATION INFORMATION for Safe Operating Area.

12. Performance guaranteed over the indicated operating temperature range by design and/or characterization.

13. Power dissipation must be limited to prevent junction temperature from exceeding 150°C . See Absolute Maximum Ratings for more information.

NCS20071, NCV20071, NCS20072, NCV20072, NCS20074, NCV20074

ELECTRICAL CHARACTERISTICS AT $V_S = 2.7\text{ V}$

$T_A = 25^\circ\text{C}$; $R_L \geq 10\text{ k}\Omega$; $V_{CM} = V_{OUT} = \text{mid-supply}$ unless otherwise noted. All limits are guaranteed by testing or statistical analysis. **Boldface** limits apply over the specified temperature range, $T_A = -40^\circ\text{C}$ to 125°C . (Notes 11, 12)

Parameter	Symbol	Conditions	Min	Typ	Max	Unit
NOISE CHARACTERISTICS						
Total Harmonic Distortion plus Noise	THD+N	$V_{IN} = 0.5\text{ V}_{pp}$, $f = 1\text{ kHz}$, $A_v = 1$		0.05		%
Input Referred Voltage Noise	e_n	$f = 1\text{ kHz}$		30		$\text{nV}/\sqrt{\text{Hz}}$
		$f = 10\text{ kHz}$		20		
Input Referred Current Noise	i_n	$f = 1\text{ kHz}$		90		$\text{fA}/\sqrt{\text{Hz}}$

SUPPLY CHARACTERISTICS

Power Supply Rejection Ratio	PSRR	No Load		114	135		dB
				100			
Power Supply Quiescent Current	I_{DD}	NCx20071	No load		420	625	μA
						765	
		NCx20072, NCx20074	Per channel, no load		405	525	
						625	

Product parametric performance is indicated in the Electrical Characteristics for the listed test conditions, unless otherwise noted. Product performance may not be indicated by the Electrical Characteristics if operated under different conditions.

11. Refer to ABSOLUTE MAXIMUM RATINGS and APPLICATION INFORMATION for Safe Operating Area.

12. Performance guaranteed over the indicated operating temperature range by design and/or characterization.

13. Power dissipation must be limited to prevent junction temperature from exceeding 150°C . See Absolute Maximum Ratings for more information.

ELECTRICAL CHARACTERISTICS AT $V_S = 5\text{ V}$

$T_A = 25^\circ\text{C}$; $R_L \geq 10\text{ k}\Omega$; $V_{CM} = V_{OUT} = \text{mid-supply}$ unless otherwise noted. All limits are guaranteed by testing or statistical analysis. **Boldface** limits apply over the specified temperature range, $T_A = -40^\circ\text{C}$ to 125°C . (Notes 14, 15)

Parameter	Symbol	Conditions	Min	Typ	Max	Unit
INPUT CHARACTERISTICS						
Input Offset Voltage	V_{OS}	NCx20071		1.3	± 3.5	mV
					± 4.5	
		NCx20072, NCx20074		1.3	± 3	
					± 4	
Offset Voltage Drift	$\Delta V_{OS}/\Delta T$	$T_A = 25^\circ\text{C}$ to 125°C		2		$\mu\text{V}/^\circ\text{C}$
Input Bias Current (Note 15)	I_{IB}			5	200	pA
					1500	
Input Offset Current (Note 15)	I_{OS}	NCx20071, NCx20072		2	75	pA
					500	
		NCx20074		2	75	
					200	
Channel Separation	XTLK	DC	NCx20072		100	dB
			NCx20074		115	
Differential Input Resistance	R_{ID}			5		$\text{G}\Omega$
Common Mode Input Resistance	R_{IN}			5		$\text{G}\Omega$
Differential Input Capacitance	C_{ID}			1.5		pF
Common Mode Input Capacitance	C_{CM}			3.5		pF

Product parametric performance is indicated in the Electrical Characteristics for the listed test conditions, unless otherwise noted. Product performance may not be indicated by the Electrical Characteristics if operated under different conditions.

14. Refer to ABSOLUTE MAXIMUM RATINGS and APPLICATION INFORMATION for Safe Operating Area.

15. Performance guaranteed over the indicated operating temperature range by design and/or characterization.

16. Power dissipation must be limited to prevent junction temperature from exceeding 150°C . See Absolute Maximum Ratings for more information.

NCS20071, NCV20071, NCS20072, NCV20072, NCS20074, NCV20074

ELECTRICAL CHARACTERISTICS AT $V_S = 5\text{ V}$

$T_A = 25^\circ\text{C}$; $R_L \geq 10\text{ k}\Omega$; $V_{CM} = V_{OUT} = \text{mid-supply}$ unless otherwise noted. All limits are guaranteed by testing or statistical analysis.

Boldface limits apply over the specified temperature range, $T_A = -40^\circ\text{C}$ to 125°C . (Notes 14, 15)

Parameter	Symbol	Conditions	Min	Typ	Max	Unit
-----------	--------	------------	-----	-----	-----	------

INPUT CHARACTERISTICS

Common Mode Rejection Ratio	CMRR	$V_{CM} = V_{SS} + 0.2\text{ V}$ to $V_{DD} - 1.35\text{ V}$	102	125		dB
			80			

OUTPUT CHARACTERISTICS

Open Loop Voltage Gain	A_{VOL}		96	120		dB
			86			
Output Current Capability (Note 16)	I_O	Op amp sinking current		50		mA
		Op amp sourcing current		60		
Output Voltage High	V_{OH}	Voltage output swing from positive rail		0.013	0.20	V
					0.25	
Output Voltage Low	V_{OL}	Voltage output swing from negative rail		0.01	0.10	V
					0.15	

AC CHARACTERISTICS

Unity Gain Bandwidth	UGBW	$C_L = 25\text{ pF}$		3		MHz
Slew Rate at Unity Gain	SR	$C_L = 20\text{ pF}$, $R_L = 2\text{ k}\Omega$		2.7		V/ μs
Phase Margin	φ_m	$C_L = 25\text{ pF}$		50		$^\circ$
Gain Margin	A_m	$C_L = 25\text{ pF}$		14		dB
Settling Time	t_s	$V_O = 3\text{ Vpp}$, Gain = 1, $C_L = 20\text{ pF}$	Settling time to 0.1%	1.2		μs
			Settling time to 0.01%	5.6		

NOISE CHARACTERISTICS

Total Harmonic Distortion plus Noise	THD+N	$V_{IN} = 2.5\text{ Vpp}$, $f = 1\text{ kHz}$, $A_v = 1$		0.009		%
Input Referred Voltage Noise	e_n	$f = 1\text{ kHz}$		30		nV/ $\sqrt{\text{Hz}}$
		$f = 10\text{ kHz}$		20		
Input Referred Current Noise	i_n	$f = 1\text{ kHz}$		90		fA/ $\sqrt{\text{Hz}}$

SUPPLY CHARACTERISTICS

Power Supply Rejection Ratio	PSRR	No Load		114	135		dB
				100			
Power Supply Quiescent Current	I_{DD}	NCx20071	No load		430	635	μA
						775	
		NCx20072, NCx20074	Per channel, no load		410	530	
						630	

Product parametric performance is indicated in the Electrical Characteristics for the listed test conditions, unless otherwise noted. Product performance may not be indicated by the Electrical Characteristics if operated under different conditions.

14. Refer to ABSOLUTE MAXIMUM RATINGS and APPLICATION INFORMATION for Safe Operating Area.

15. Performance guaranteed over the indicated operating temperature range by design and/or characterization.

16. Power dissipation must be limited to prevent junction temperature from exceeding 150°C . See Absolute Maximum Ratings for more information.

NCS20071, NCV20071, NCS20072, NCV20072, NCS20074, NCV20074

ELECTRICAL CHARACTERISTICS AT $V_S = 10\text{ V}$

$T_A = 25^\circ\text{C}$; $R_L \geq 10\text{ k}\Omega$; $V_{CM} = V_{OUT} = \text{mid-supply}$ unless otherwise noted. All limits are guaranteed by testing or statistical analysis. Boldface limits apply over the specified temperature range, $T_A = -40^\circ\text{C}$ to 125°C . (Notes 17, 18)

Parameter	Symbol	Conditions	Min	Typ	Max	Unit
INPUT CHARACTERISTICS						
Input Offset Voltage	V_{OS}	NCx20071		1.3	± 3.5	mV
					± 4.5	mV
Input Offset Voltage	V_{OS}	NCx20072, NCx20074		1.3	± 3	mV
					± 4	mV
Offset Voltage Drift	$\Delta V_{OS}/\Delta T$	$T_A = 25^\circ\text{C}$ to 125°C		2		$\mu\text{V}/^\circ\text{C}$
Input Bias Current (Note 18)	I_{IB}			5	200	pA
					1500	
Input Offset Current (Note 18)	I_{OS}	NCx20071, NCx20072		2	75	pA
					500	
		NCx20074		2	75	
					200	
Channel Separation	XTLK	DC	NCx20072	100		dB
			NCx20074	115		
Differential Input Resistance	R_{ID}			5		$\text{G}\Omega$
Common Mode Input Resistance	R_{IN}			5		$\text{G}\Omega$
Differential Input Capacitance	C_{ID}			1.5		pF
Common Mode Input Capacitance	C_{CM}			3.5		pF
Common Mode Rejection Ratio	CMRR	$V_{CM} = V_{SS} + 0.2\text{ V}$ to $V_{DD} - 1.35\text{ V}$		110	130	dB
				87		

OUTPUT CHARACTERISTICS

Open Loop Voltage Gain	A_{VOL}			98	120	dB
				88		
Output Current Capability (Note 19)	I_O		Op amp sinking current		50	mA
			Op amp sourcing current		65	
Output Voltage High	V_{OH}	Voltage output swing from positive rail		0.023	0.08	V
					0.10	
Output Voltage Low	V_{OL}	Voltage output swing from negative rail		0.022	0.3	V
					0.35	

AC CHARACTERISTICS

Unity Gain Bandwidth	UGBW	$C_L = 25\text{ pF}$		3		MHz
Slew Rate at Unity Gain	SR	$C_L = 20\text{ pF}$, $R_L = 2\text{ k}\Omega$		2.6		$\text{V}/\mu\text{s}$
Phase Margin	φ_m	$C_L = 25\text{ pF}$		50		$^\circ$
Gain Margin	A_m	$C_L = 25\text{ pF}$		14		dB
Settling Time	t_s	$V_O = 8.5\text{ Vpp}$, Gain = 1, $C_L = 20\text{ pF}$	Settling time to 0.1%	3.4		μs
			Settling time to 0.01%	6.8		

Product parametric performance is indicated in the Electrical Characteristics for the listed test conditions, unless otherwise noted. Product performance may not be indicated by the Electrical Characteristics if operated under different conditions.

17. Refer to ABSOLUTE MAXIMUM RATINGS and APPLICATION INFORMATION for Safe Operating Area.

18. Performance guaranteed over the indicated operating temperature range by design and/or characterization.

19. Power dissipation must be limited to prevent junction temperature from exceeding 150°C . See Absolute Maximum Ratings for more information.

NCS20071, NCV20071, NCS20072, NCV20072, NCS20074, NCV20074

ELECTRICAL CHARACTERISTICS AT $V_S = 10\text{ V}$

$T_A = 25^\circ\text{C}$; $R_L \geq 10\text{ k}\Omega$; $V_{CM} = V_{OUT} = \text{mid-supply}$ unless otherwise noted. All limits are guaranteed by testing or statistical analysis. Boldface limits apply over the specified temperature range, $T_A = -40^\circ\text{C}$ to 125°C . (Notes 17, 18)

Parameter	Symbol	Conditions	Min	Typ	Max	Unit
NOISE CHARACTERISTICS						
Total Harmonic Distortion plus Noise	THD+N	$V_{IN} = 7.5\text{ Vpp}$, $f = 1\text{ kHz}$, $A_v = 1$		0.004		%
Input Referred Voltage Noise	e_n	$f = 1\text{ kHz}$		30		$\text{nV}/\sqrt{\text{Hz}}$
		$f = 10\text{ kHz}$		20		
Input Referred Current Noise	i_n	$f = 1\text{ kHz}$		90		$\text{fA}/\sqrt{\text{Hz}}$

SUPPLY CHARACTERISTICS

Power Supply Rejection Ratio	PSRR	No Load		114	135		dB
				100			
Power Supply Quiescent Current	I_{DD}	NCx20071	No load		430	645	μA
						785	
		NCx20072, NCx20074	Per channel, no load		416	540	
						640	

Product parametric performance is indicated in the Electrical Characteristics for the listed test conditions, unless otherwise noted. Product performance may not be indicated by the Electrical Characteristics if operated under different conditions.

17. Refer to ABSOLUTE MAXIMUM RATINGS and APPLICATION INFORMATION for Safe Operating Area.

18. Performance guaranteed over the indicated operating temperature range by design and/or characterization.

19. Power dissipation must be limited to prevent junction temperature from exceeding 150°C . See Absolute Maximum Ratings for more information.

ELECTRICAL CHARACTERISTICS AT $V_S = 36\text{ V}$

$T_A = 25^\circ\text{C}$; $R_L \geq 10\text{ k}\Omega$; $V_{CM} = V_{OUT} = \text{mid-supply}$ unless otherwise noted. All limits are guaranteed by testing or statistical analysis. Boldface limits apply over the specified temperature range, $T_A = -40^\circ\text{C}$ to 125°C . (Notes 20, 21)

Parameter	Symbol	Conditions	Min	Typ	Max	Unit	
INPUT CHARACTERISTICS							
Input Offset Voltage	V_{OS}	NCx20071		1.3	± 3.5	mV	
						± 4.5	mV
		NCx20072, NCx20074		1.3	± 3	mV	
						± 4	mV
Offset Voltage Drift	$\Delta V_{OS}/\Delta T$	$T_A = 25^\circ\text{C}$ to 125°C		2		$\mu\text{V}/^\circ\text{C}$	
Input Bias Current (Note 21)	I_{IB}			5	200	pA	
				NCx20071, NCx20072			2000
				NCx20074			1500
Input Offset Current (Note 21)	I_{OS}	NCx20071, NCx20072		2	75	pA	
							1000
		NCx20074		2	75		
							200
Channel Separation	XTLK	DC	NCx20072		100	dB	
			NCx20074		115		
Differential Input Resistance	R_{ID}			5		$\text{G}\Omega$	
Common Mode Input Resistance	R_{IN}			5		$\text{G}\Omega$	

Product parametric performance is indicated in the Electrical Characteristics for the listed test conditions, unless otherwise noted. Product performance may not be indicated by the Electrical Characteristics if operated under different conditions.

20. Refer to ABSOLUTE MAXIMUM RATINGS and APPLICATION INFORMATION for Safe Operating Area.

21. Performance guaranteed over the indicated operating temperature range by design and/or characterization.

22. Power dissipation must be limited to prevent junction temperature from exceeding 150°C . See Absolute Maximum Ratings for more information.

NCS20071, NCV20071, NCS20072, NCV20072, NCS20074, NCV20074

ELECTRICAL CHARACTERISTICS AT $V_S = 36\text{ V}$

$T_A = 25^\circ\text{C}$; $R_L \geq 10\text{ k}\Omega$; $V_{CM} = V_{OUT} = \text{mid-supply}$ unless otherwise noted. All limits are guaranteed by testing or statistical analysis. Boldface limits apply over the specified temperature range, $T_A = -40^\circ\text{C}$ to 125°C . (Notes 20, 21)

Parameter	Symbol	Conditions	Min	Typ	Max	Unit
-----------	--------	------------	-----	-----	-----	------

INPUT CHARACTERISTICS

Differential Input Capacitance	C_{ID}			1.5		pF
Common Mode Input Capacitance	C_{CM}			3.5		pF
Common Mode Rejection Ratio	CMRR	NCx20071	$V_{CM} = V_{SS} + 0.2\text{ V}$ to $V_{DD} - 1.35\text{ V}$	118	135	dB
				95		
		NCx20072	$V_{CM} = V_{SS} + 0.2\text{ V}$ to $V_{DD} - 1.35\text{ V}$	120	145	
				95		
		NCx20074	$V_{CM} = V_{SS} + 0.2\text{ V}$ to $V_{DD} - 1.35\text{ V}$	120	145	
				85		

OUTPUT CHARACTERISTICS

Open Loop Voltage Gain	A_{VOL}		98	120	dB	
			88			
Output Current Capability (Note 22)	I_O	Op amp sinking current		50	mA	
		Op amp sourcing current		65		
Output Voltage High	V_{OH}	Voltage output swing from positive rail	NCx20071	0.074	0.15	V
				0.22		
			NCx20072	0.074	0.10	
				0.15		
			NCx20074	0.074	0.10	
				0.12		
Output Voltage Low	V_{OL}	Voltage output swing from negative rail		0.065	0.3	V
					0.35	

AC CHARACTERISTICS

Unity Gain Bandwidth	UGBW	$C_L = 25\text{ pF}$		3		MHz
Slew Rate at Unity Gain	SR	$C_L = 20\text{ pF}$, $R_L = 2\text{ k}\Omega$		2.4		$\text{V}/\mu\text{s}$
Phase Margin	φ_m	$C_L = 25\text{ pF}$		50		$^\circ$
Gain Margin	A_m	$C_L = 25\text{ pF}$		14		dB
Settling Time	t_s	$V_O = 10\text{ Vpp}$, Gain = 1, $C_L = 20\text{ pF}$	Settling time to 0.1%	3.2		μs
			Settling time to 0.01%	7		

NOISE CHARACTERISTICS

Total Harmonic Distortion plus Noise	THD+N	$V_{IN} = 28.5\text{ Vpp}$, $f = 1\text{ kHz}$, $A_v = 1$		0.001		%
Input Referred Voltage Noise	e_n	$f = 1\text{ kHz}$		30		$\text{nV}/\sqrt{\text{Hz}}$
		$f = 10\text{ kHz}$		20		
Input Referred Current Noise	i_n	$f = 1\text{ kHz}$		90		$\text{fA}/\sqrt{\text{Hz}}$

Product parametric performance is indicated in the Electrical Characteristics for the listed test conditions, unless otherwise noted. Product performance may not be indicated by the Electrical Characteristics if operated under different conditions.

20. Refer to ABSOLUTE MAXIMUM RATINGS and APPLICATION INFORMATION for Safe Operating Area.

21. Performance guaranteed over the indicated operating temperature range by design and/or characterization.

22. Power dissipation must be limited to prevent junction temperature from exceeding 150°C . See Absolute Maximum Ratings for more information.

NCS20071, NCV20071, NCS20072, NCV20072, NCS20074, NCV20074

ELECTRICAL CHARACTERISTICS AT $V_S = 36\text{ V}$

$T_A = 25^\circ\text{C}$; $R_L \geq 10\text{ k}\Omega$; $V_{CM} = V_{OUT} = \text{mid-supply}$ unless otherwise noted. All limits are guaranteed by testing or statistical analysis. Boldface limits apply over the specified temperature range, $T_A = -40^\circ\text{C}$ to 125°C . (Notes 20, 21)

Parameter	Symbol	Conditions	Min	Typ	Max	Unit
-----------	--------	------------	-----	-----	-----	------

SUPPLY CHARACTERISTICS

Power Supply Rejection Ratio	PSRR	No Load		114	135		dB
				100			
Power Supply Quiescent Current	I _{DD}	NCx20071	No load		480	700	μA
						840	
		NCx20072	Per channel, no load		465	570	
						700	
		NCx20074	Per channel, no load		465	600	
						700	

Product parametric performance is indicated in the Electrical Characteristics for the listed test conditions, unless otherwise noted. Product performance may not be indicated by the Electrical Characteristics if operated under different conditions.

20. Refer to ABSOLUTE MAXIMUM RATINGS and APPLICATION INFORMATION for Safe Operating Area.

21. Performance guaranteed over the indicated operating temperature range by design and/or characterization.

22. Power dissipation must be limited to prevent junction temperature from exceeding 150°C . See Absolute Maximum Ratings for more information.



Figure 2. Quiescent Current Per Channel vs. Supply Voltage



Figure 3. Quiescent Current vs. Temperature



Figure 4. Offset Voltage vs. Supply Voltage



Figure 5. Input Offset Voltage vs. Common Mode Voltage



Figure 6. Input Offset Voltage vs. Common Mode Voltage

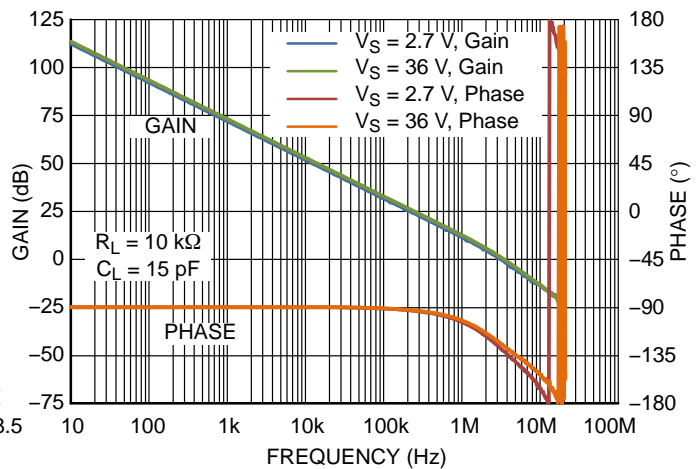

Figure 7. Gain and Phase vs. Frequency

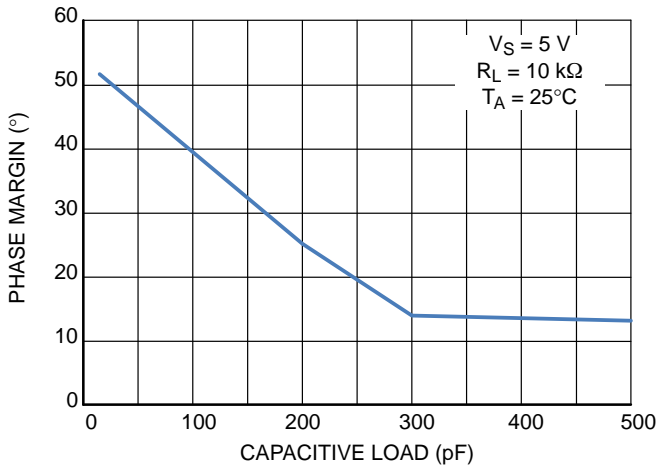

Figure 8. Phase Margin vs. Capacitive Load



Figure 9. THD+N vs. Output Voltage



Figure 10. THD+N vs. Frequency



Figure 11. Input Voltage Noise vs. Frequency



Figure 12. Input Current Noise vs. Frequency

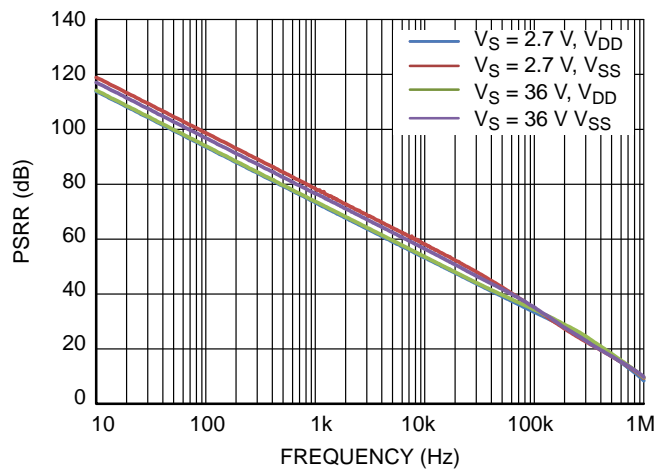

Figure 13. PSRR vs. Frequency

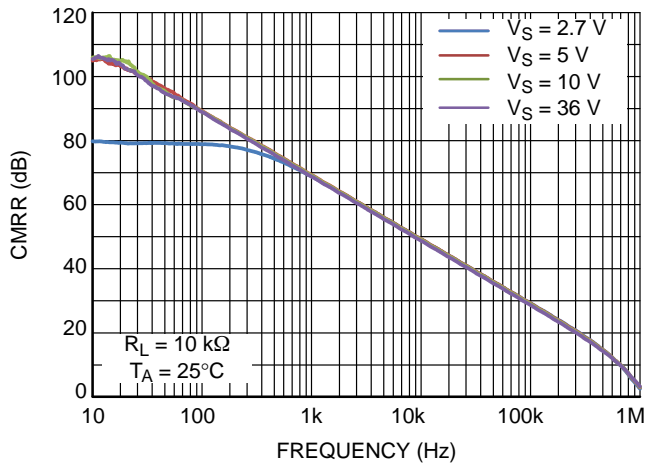

Figure 14. CMRR vs. Frequency



Figure 15. High Level Output vs. Output Current



Figure 16. Low Level Output vs. Output Current



Figure 17. Non-inverting Small Signal Transient Response

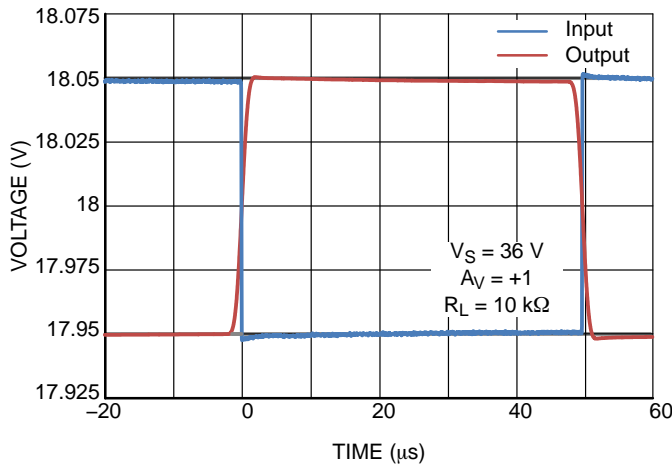

Figure 18. Inverting Small Signal Transient Response



Figure 19. Non-inverting Large Signal Transient Response



Figure 20. Inverting Large Signal Transient Response



Figure 21. Input Bias and Offset Current vs. Temperature



Figure 22. Input Bias Current vs. Common Mode Voltage

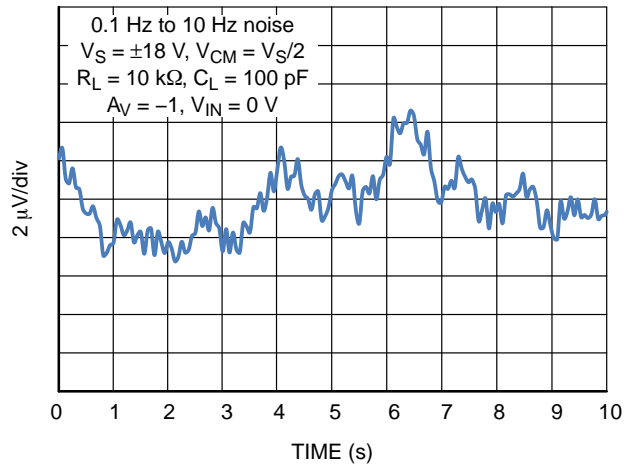

Figure 23. 0.1 Hz to 10 Hz Noise

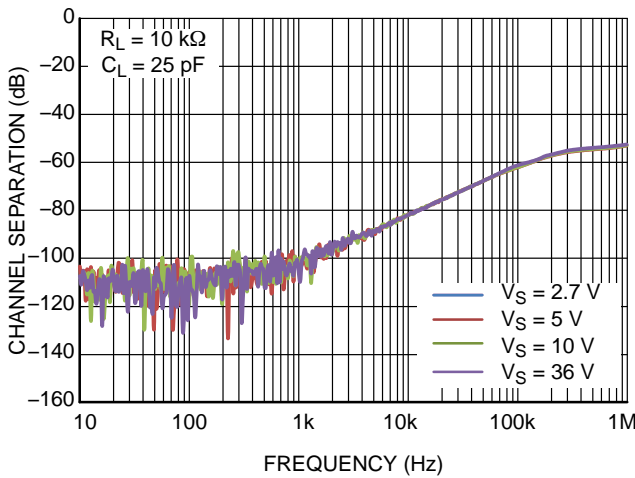

Figure 24. Channel Separation vs. Frequency

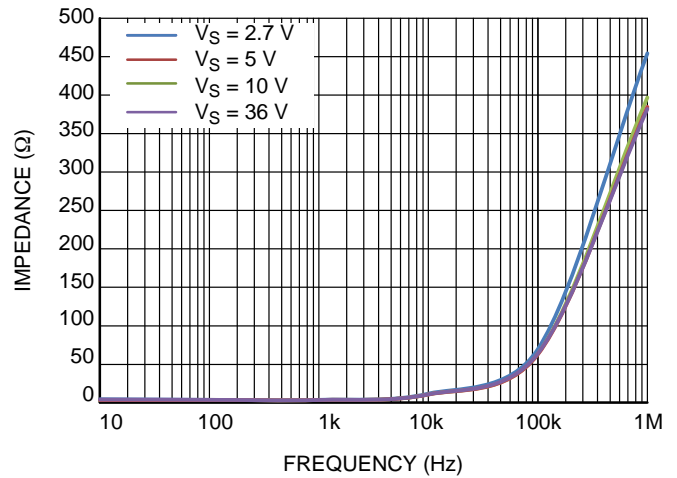

Figure 25. Open Loop Output Impedance



Figure 26. Offset Voltage vs. Temperature



Figure 27. Large Signal Settling Time



Figure 28. Slew Rate vs. Temperature

APPLICATIONS INFORMATION

Input Circuit

The NCS2007x input stage has a PMOS input pair and ESD protection diodes. The input pair is internally connected by back-to-back Zener diodes with a reverse voltage of 5.5 V. To protect the internal circuitry, the input current must be limited to 10 mA. When operating the

NCS2007x at differential voltages greater than $V_{ID} = 26$ V, series resistors can be added externally to limit the input current flowing between the input pins. Adding 500 Ω resistors in series with the input prevents the current from exceeding 10 mA over the entire operating range up to 36 V.



Figure 29. Differential Input Pair

Output

The NCS2007x has a class AB output stage with rail-to-rail output swing.

High output currents can cause the junction temperature to exceed the 150°C absolute maximum rating. In the case of a short circuit where the output is connected to either supply rail, the amount of current the op amp can source and sink is described by the output current capability parameter

listed in the Electrical Characteristics. The junction temperature at a given power dissipation, P, can be calculated using the following formula:

$$T_J = T_A + P \times \theta_{JA}$$

The thermal resistance between junction and ambient, θ_{JA} , is provided in the Thermal Information section of this datasheet.

MECHANICAL CASE OUTLINE

PACKAGE DIMENSIONS

ON Semiconductor®



SCALE 4:1

SOT-553, 5 LEAD CASE 463B ISSUE C

DATE 20 MAR 2013



NOTES:

1. DIMENSIONING AND TOLERANCING PER ANSI Y14.5M, 1982.
2. CONTROLLING DIMENSION: MILLIMETERS
3. MAXIMUM LEAD THICKNESS INCLUDES LEAD FINISH THICKNESS. MINIMUM LEAD THICKNESS IS THE MINIMUM THICKNESS OF BASE MATERIAL.

DIM	MILLIMETERS			INCHES		
	MIN	NOM	MAX	MIN	NOM	MAX
A	0.50	0.55	0.60	0.020	0.022	0.024
b	0.17	0.22	0.27	0.007	0.009	0.011
c	0.08	0.13	0.18	0.003	0.005	0.007
D	1.55	1.60	1.65	0.061	0.063	0.065
E	1.15	1.20	1.25	0.045	0.047	0.049
e	0.50 BSC			0.020 BSC		
L	0.10	0.20	0.30	0.004	0.008	0.012
H _E	1.55	1.60	1.65	0.061	0.063	0.065

RECOMMENDED SOLDERING FOOTPRINT*

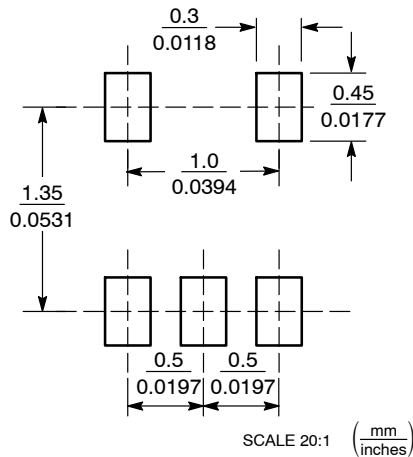

SCALE 20:1 ($\frac{\text{mm}}{\text{inches}}$)

GENERIC MARKING DIAGRAM*



- XX = Specific Device Code
- M = Date Code
- = Pb-Free Package

(Note: Microdot may be in either location)

*This information is generic. Please refer to device data sheet for actual part marking. Pb-Free indicator, "G" or microdot "▪", may or may not be present.

*For additional information on our Pb-Free strategy and soldering details, please download the ON Semiconductor Soldering and Mounting Techniques Reference Manual, SOLDERRM/D.

STYLE 1:

- PIN 1. BASE
- 2. EMITTER
- 3. BASE
- 4. COLLECTOR
- 5. COLLECTOR

STYLE 2:

- PIN 1. CATHODE
- 2. COMMON ANODE
- 3. CATHODE 2
- 4. CATHODE 3
- 5. CATHODE 4

STYLE 3:

- PIN 1. ANODE 1
- 2. N/C
- 3. ANODE 2
- 4. CATHODE 2
- 5. CATHODE 1

STYLE 4:

- PIN 1. SOURCE 1
- 2. DRAIN 1/2
- 3. SOURCE 1
- 4. GATE 1
- 5. GATE 2

STYLE 5:

- PIN 1. ANODE
- 2. EMITTER
- 3. BASE
- 4. COLLECTOR
- 5. CATHODE

STYLE 6:

- PIN 1. EMITTER 2
- 2. BASE 2
- 3. EMITTER 1
- 4. COLLECTOR 1
- 5. COLLECTOR 2/BASE 1

STYLE 7:

- PIN 1. BASE
- 2. EMITTER
- 3. BASE
- 4. COLLECTOR
- 5. COLLECTOR

STYLE 8:

- PIN 1. CATHODE
- 2. COLLECTOR
- 3. N/C
- 4. BASE
- 5. EMITTER

STYLE 9:

- PIN 1. ANODE
- 2. CATHODE
- 3. ANODE
- 4. ANODE
- 5. ANODE

DOCUMENT NUMBER:	98AON11127D	Electronic versions are uncontrolled except when accessed directly from the Document Repository. Printed versions are uncontrolled except when stamped "CONTROLLED COPY" in red.
STATUS:	ON SEMICONDUCTOR STANDARD	
NEW STANDARD:		
DESCRIPTION:	SOT-553, 5 LEAD	PAGE 1 OF 2

MECHANICAL CASE OUTLINE

PACKAGE DIMENSIONS

ON Semiconductor®



SCALE 2:1

TSOP-5 CASE 483 ISSUE N

DATE 12 AUG 2020



NOTES:

1. DIMENSIONING AND TOLERANCING PER ASME Y14.5M, 1994.
2. CONTROLLING DIMENSION: MILLIMETERS.
3. MAXIMUM LEAD THICKNESS INCLUDES LEAD FINISH THICKNESS. MINIMUM LEAD THICKNESS IS THE MINIMUM THICKNESS OF BASE MATERIAL.
4. DIMENSIONS A AND B DO NOT INCLUDE MOLD FLASH, PROTRUSIONS, OR GATE BURRS. MOLD FLASH, PROTRUSIONS, OR GATE BURRS SHALL NOT EXCEED 0.15 PER SIDE. DIMENSION A.
5. OPTIONAL CONSTRUCTION: AN ADDITIONAL TRIMMED LEAD IS ALLOWED IN THIS LOCATION. TRIMMED LEAD NOT TO EXTEND MORE THAN 0.2 FROM BODY.

DIM	MILLIMETERS	
	MIN	MAX
A	2.85	3.15
B	1.35	1.65
C	0.90	1.10
D	0.25	0.50
G	0.95 BSC	
H	0.01	0.10
J	0.10	0.26
K	0.20	0.60
M	0°	10°
S	2.50	3.00

SOLDERING FOOTPRINT*



*For additional information on our Pb-Free strategy and soldering details, please download the ON Semiconductor Soldering and Mounting Techniques Reference Manual, SOLDERRM/D.

GENERIC MARKING DIAGRAM*



- XXX = Specific Device Code
 A = Assembly Location
 Y = Year
 W = Work Week
 ■ = Pb-Free Package
- XXX = Specific Device Code
 M = Date Code
 ■ = Pb-Free Package

(Note: Microdot may be in either location)

*This information is generic. Please refer to device data sheet for actual part marking. Pb-Free indicator, "G" or microdot "■", may or may not be present.

DOCUMENT NUMBER:	98ARB18753C	Electronic versions are uncontrolled except when accessed directly from the Document Repository. Printed versions are uncontrolled except when stamped "CONTROLLED COPY" in red.
DESCRIPTION:	TSOP-5	PAGE 1 OF 1

ON Semiconductor and ON are trademarks of Semiconductor Components Industries, LLC dba ON Semiconductor or its subsidiaries in the United States and/or other countries. ON Semiconductor reserves the right to make changes without further notice to any products herein. ON Semiconductor makes no warranty, representation or guarantee regarding the suitability of its products for any particular purpose, nor does ON Semiconductor assume any liability arising out of the application or use of any product or circuit, and specifically disclaims any and all liability, including without limitation special, consequential or incidental damages. ON Semiconductor does not convey any license under its patent rights nor the rights of others.

MECHANICAL CASE OUTLINE PACKAGE DIMENSIONS



SCALE 1:1

SOIC-8 NB
CASE 751-07
ISSUE AK

DATE 16 FEB 2011



- NOTES:
1. DIMENSIONING AND TOLERANCING PER ANSI Y14.5M, 1982.
 2. CONTROLLING DIMENSION: MILLIMETER.
 3. DIMENSION A AND B DO NOT INCLUDE MOLD PROTRUSION.
 4. MAXIMUM MOLD PROTRUSION 0.15 (0.006) PER SIDE.
 5. DIMENSION D DOES NOT INCLUDE DAMBAR PROTRUSION. ALLOWABLE DAMBAR PROTRUSION SHALL BE 0.127 (0.005) TOTAL IN EXCESS OF THE D DIMENSION AT MAXIMUM MATERIAL CONDITION.
 6. 751-01 THRU 751-06 ARE OBSOLETE. NEW STANDARD IS 751-07.

DIM	MILLIMETERS		INCHES	
	MIN	MAX	MIN	MAX
A	4.80	5.00	0.189	0.197
B	3.80	4.00	0.150	0.157
C	1.35	1.75	0.053	0.069
D	0.33	0.51	0.013	0.020
G	1.27 BSC		0.050 BSC	
H	0.10	0.25	0.004	0.010
J	0.19	0.25	0.007	0.010
K	0.40	1.27	0.016	0.050
M	0°	8°	0°	8°
N	0.25	0.50	0.010	0.020
S	5.80	6.20	0.228	0.244

GENERIC MARKING DIAGRAM*



SCALE 6:1 ($\frac{\text{mm}}{\text{inches}}$)



XXXXXX = Specific Device Code
A = Assembly Location
L = Wafer Lot
Y = Year
W = Work Week
▪ = Pb-Free Package

XXXXXX = Specific Device Code
A = Assembly Location
Y = Year
WW = Work Week
▪ = Pb-Free Package

*This information is generic. Please refer to device data sheet for actual part marking. Pb-Free indicator, "G" or microdot "▪", may or may not be present. Some products may not follow the Generic Marking.

*For additional information on our Pb-Free strategy and soldering details, please download the ON Semiconductor Soldering and Mounting Techniques Reference Manual, SOLDERRM/D.

STYLES ON PAGE 2

DOCUMENT NUMBER:	98ASB42564B	Electronic versions are uncontrolled except when accessed directly from the Document Repository. Printed versions are uncontrolled except when stamped "CONTROLLED COPY" in red.
DESCRIPTION:	SOIC-8 NB	PAGE 1 OF 2

onsemi and ONsemi are trademarks of Semiconductor Components Industries, LLC dba onsemi or its subsidiaries in the United States and/or other countries. onsemi reserves the right to make changes without further notice to any products herein. onsemi makes no warranty, representation or guarantee regarding the suitability of its products for any particular purpose, nor does onsemi assume any liability arising out of the application or use of any product or circuit, and specifically disclaims any and all liability, including without limitation special, consequential or incidental damages. onsemi does not convey any license under its patent rights nor the rights of others.

SOIC-8 NB
CASE 751-07
ISSUE AK

DATE 16 FEB 2011

- | | | | |
|---|--|--|--|
| <p>STYLE 1:
 PIN 1. EMITTER
 2. COLLECTOR
 3. COLLECTOR
 4. EMITTER
 5. EMITTER
 6. BASE
 7. BASE
 8. EMITTER</p> | <p>STYLE 2:
 PIN 1. COLLECTOR, DIE, #1
 2. COLLECTOR, #1
 3. COLLECTOR, #2
 4. COLLECTOR, #2
 5. BASE, #2
 6. EMITTER, #2
 7. BASE, #1
 8. EMITTER, #1</p> | <p>STYLE 3:
 PIN 1. DRAIN, DIE #1
 2. DRAIN, #1
 3. DRAIN, #2
 4. DRAIN, #2
 5. GATE, #2
 6. SOURCE, #2
 7. GATE, #1
 8. SOURCE, #1</p> | <p>STYLE 4:
 PIN 1. ANODE
 2. ANODE
 3. ANODE
 4. ANODE
 5. ANODE
 6. ANODE
 7. ANODE
 8. COMMON CATHODE</p> |
| <p>STYLE 5:
 PIN 1. DRAIN
 2. DRAIN
 3. DRAIN
 4. DRAIN
 5. GATE
 6. GATE
 7. SOURCE
 8. SOURCE</p> | <p>STYLE 6:
 PIN 1. SOURCE
 2. DRAIN
 3. DRAIN
 4. SOURCE
 5. SOURCE
 6. GATE
 7. GATE
 8. SOURCE</p> | <p>STYLE 7:
 PIN 1. INPUT
 2. EXTERNAL BYPASS
 3. THIRD STAGE SOURCE
 4. GROUND
 5. DRAIN
 6. GATE 3
 7. SECOND STAGE Vd
 8. FIRST STAGE Vd</p> | <p>STYLE 8:
 PIN 1. COLLECTOR, DIE #1
 2. BASE, #1
 3. BASE, #2
 4. COLLECTOR, #2
 5. COLLECTOR, #2
 6. EMITTER, #2
 7. EMITTER, #1
 8. COLLECTOR, #1</p> |
| <p>STYLE 9:
 PIN 1. EMITTER, COMMON
 2. COLLECTOR, DIE #1
 3. COLLECTOR, DIE #2
 4. EMITTER, COMMON
 5. EMITTER, COMMON
 6. BASE, DIE #2
 7. BASE, DIE #1
 8. EMITTER, COMMON</p> | <p>STYLE 10:
 PIN 1. GROUND
 2. BIAS 1
 3. OUTPUT
 4. GROUND
 5. GROUND
 6. BIAS 2
 7. INPUT
 8. GROUND</p> | <p>STYLE 11:
 PIN 1. SOURCE 1
 2. GATE 1
 3. SOURCE 2
 4. GATE 2
 5. DRAIN 2
 6. DRAIN 2
 7. DRAIN 1
 8. DRAIN 1</p> | <p>STYLE 12:
 PIN 1. SOURCE
 2. SOURCE
 3. SOURCE
 4. GATE
 5. DRAIN
 6. DRAIN
 7. DRAIN
 8. DRAIN</p> |
| <p>STYLE 13:
 PIN 1. N.C.
 2. SOURCE
 3. SOURCE
 4. GATE
 5. DRAIN
 6. DRAIN
 7. DRAIN
 8. DRAIN</p> | <p>STYLE 14:
 PIN 1. N-SOURCE
 2. N-GATE
 3. P-SOURCE
 4. P-GATE
 5. P-DRAIN
 6. P-DRAIN
 7. N-DRAIN
 8. N-DRAIN</p> | <p>STYLE 15:
 PIN 1. ANODE 1
 2. ANODE 1
 3. ANODE 1
 4. ANODE 1
 5. CATHODE, COMMON
 6. CATHODE, COMMON
 7. CATHODE, COMMON
 8. CATHODE, COMMON</p> | <p>STYLE 16:
 PIN 1. EMITTER, DIE #1
 2. BASE, DIE #1
 3. EMITTER, DIE #2
 4. BASE, DIE #2
 5. COLLECTOR, DIE #2
 6. COLLECTOR, DIE #2
 7. COLLECTOR, DIE #1
 8. COLLECTOR, DIE #1</p> |
| <p>STYLE 17:
 PIN 1. VCC
 2. V2OUT
 3. V1OUT
 4. TXE
 5. RXE
 6. VEE
 7. GND
 8. ACC</p> | <p>STYLE 18:
 PIN 1. ANODE
 2. ANODE
 3. SOURCE
 4. GATE
 5. DRAIN
 6. DRAIN
 7. CATHODE
 8. CATHODE</p> | <p>STYLE 19:
 PIN 1. SOURCE 1
 2. GATE 1
 3. SOURCE 2
 4. GATE 2
 5. DRAIN 2
 6. MIRROR 2
 7. DRAIN 1
 8. MIRROR 1</p> | <p>STYLE 20:
 PIN 1. SOURCE (N)
 2. GATE (N)
 3. SOURCE (P)
 4. GATE (P)
 5. DRAIN
 6. DRAIN
 7. DRAIN
 8. DRAIN</p> |
| <p>STYLE 21:
 PIN 1. CATHODE 1
 2. CATHODE 2
 3. CATHODE 3
 4. CATHODE 4
 5. CATHODE 5
 6. COMMON ANODE
 7. COMMON ANODE
 8. CATHODE 6</p> | <p>STYLE 22:
 PIN 1. I/O LINE 1
 2. COMMON CATHODE/VCC
 3. COMMON CATHODE/VCC
 4. I/O LINE 3
 5. COMMON ANODE/GND
 6. I/O LINE 4
 7. I/O LINE 5
 8. COMMON ANODE/GND</p> | <p>STYLE 23:
 PIN 1. LINE 1 IN
 2. COMMON ANODE/GND
 3. COMMON ANODE/GND
 4. LINE 2 IN
 5. LINE 2 OUT
 6. COMMON ANODE/GND
 7. COMMON ANODE/GND
 8. LINE 1 OUT</p> | <p>STYLE 24:
 PIN 1. BASE
 2. EMITTER
 3. COLLECTOR/ANODE
 4. COLLECTOR/ANODE
 5. CATHODE
 6. CATHODE
 7. COLLECTOR/ANODE
 8. COLLECTOR/ANODE</p> |
| <p>STYLE 25:
 PIN 1. VIN
 2. N/C
 3. REXT
 4. GND
 5. IOUT
 6. IOUT
 7. IOUT
 8. IOUT</p> | <p>STYLE 26:
 PIN 1. GND
 2. dv/dt
 3. ENABLE
 4. ILIMIT
 5. SOURCE
 6. SOURCE
 7. SOURCE
 8. VCC</p> | <p>STYLE 27:
 PIN 1. ILIMIT
 2. OVLO
 3. UVLO
 4. INPUT+
 5. SOURCE
 6. SOURCE
 7. SOURCE
 8. DRAIN</p> | <p>STYLE 28:
 PIN 1. SW_TO_GND
 2. DASIC_OFF
 3. DASIC_SW_DET
 4. GND
 5. V_MON
 6. VBULK
 7. VBULK
 8. VIN</p> |
| <p>STYLE 29:
 PIN 1. BASE, DIE #1
 2. EMITTER, #1
 3. BASE, #2
 4. EMITTER, #2
 5. COLLECTOR, #2
 6. COLLECTOR, #2
 7. COLLECTOR, #1
 8. COLLECTOR, #1</p> | <p>STYLE 30:
 PIN 1. DRAIN 1
 2. DRAIN 1
 3. GATE 2
 4. SOURCE 2
 5. SOURCE 1/DRAIN 2
 6. SOURCE 1/DRAIN 2
 7. SOURCE 1/DRAIN 2
 8. GATE 1</p> | | |

DOCUMENT NUMBER:	98ASB42564B	Electronic versions are uncontrolled except when accessed directly from the Document Repository. Printed versions are uncontrolled except when stamped "CONTROLLED COPY" in red.
DESCRIPTION:	SOIC-8 NB	PAGE 2 OF 2

onsemi and **ONSEMI** are trademarks of Semiconductor Components Industries, LLC dba **onsemi** or its subsidiaries in the United States and/or other countries. **onsemi** reserves the right to make changes without further notice to any products herein. **onsemi** makes no warranty, representation or guarantee regarding the suitability of its products for any particular purpose, nor does **onsemi** assume any liability arising out of the application or use of any product or circuit, and specifically disclaims any and all liability, including without limitation special, consequential or incidental damages. **onsemi** does not convey any license under its patent rights nor the rights of others.

MECHANICAL CASE OUTLINE PACKAGE DIMENSIONS



SCALE 1:1

SOIC-14 NB
CASE 751A-03
ISSUE L

DATE 03 FEB 2016



NOTES:

1. DIMENSIONING AND TOLERANCING PER ASME Y14.5M, 1994.
2. CONTROLLING DIMENSION: MILLIMETERS.
3. DIMENSION b DOES NOT INCLUDE DAMBAR PROTRUSION. ALLOWABLE PROTRUSION SHALL BE 0.13 TOTAL IN EXCESS OF AT MAXIMUM MATERIAL CONDITION.
4. DIMENSIONS D AND E DO NOT INCLUDE MOLD PROTRUSIONS.
5. MAXIMUM MOLD PROTRUSION 0.15 PER SIDE.

DIM	MILLIMETERS		INCHES	
	MIN	MAX	MIN	MAX
A	1.35	1.75	0.054	0.068
A1	0.10	0.25	0.004	0.010
A3	0.19	0.25	0.008	0.010
b	0.35	0.49	0.014	0.019
D	8.55	8.75	0.337	0.344
E	3.80	4.00	0.150	0.157
e	1.27 BSC		0.050 BSC	
H	5.80	6.20	0.228	0.244
h	0.25	0.50	0.010	0.019
L	0.40	1.25	0.016	0.049
M	0°	7°	0°	7°

SOLDERING FOOTPRINT*



DIMENSIONS: MILLIMETERS

*For additional information on our Pb-Free strategy and soldering details, please download the ON Semiconductor Soldering and Mounting Techniques Reference Manual, SOLDERRM/D.

GENERIC MARKING DIAGRAM*



- XXXXXX = Specific Device Code
- A = Assembly Location
- WL = Wafer Lot
- Y = Year
- WW = Work Week
- G = Pb-Free Package

*This information is generic. Please refer to device data sheet for actual part marking. Pb-Free indicator, "G" or microdot "▪", may or may not be present. Some products may not follow the Generic Marking.

STYLES ON PAGE 2

DOCUMENT NUMBER:	98ASB42565B	Electronic versions are uncontrolled except when accessed directly from the Document Repository. Printed versions are uncontrolled except when stamped "CONTROLLED COPY" in red.
DESCRIPTION:	SOIC-14 NB	PAGE 1 OF 2

onsemi and onsemi are trademarks of Semiconductor Components Industries, LLC dba onsemi or its subsidiaries in the United States and/or other countries. onsemi reserves the right to make changes without further notice to any products herein. onsemi makes no warranty, representation or guarantee regarding the suitability of its products for any particular purpose, nor does onsemi assume any liability arising out of the application or use of any product or circuit, and specifically disclaims any and all liability, including without limitation special, consequential or incidental damages. onsemi does not convey any license under its patent rights nor the rights of others.

SOIC-14
CASE 751A-03
ISSUE L

DATE 03 FEB 2016

STYLE 1:
 PIN 1. COMMON CATHODE
 2. ANODE/CATHODE
 3. ANODE/CATHODE
 4. NO CONNECTION
 5. ANODE/CATHODE
 6. NO CONNECTION
 7. ANODE/CATHODE
 8. ANODE/CATHODE
 9. ANODE/CATHODE
 10. NO CONNECTION
 11. ANODE/CATHODE
 12. ANODE/CATHODE
 13. NO CONNECTION
 14. COMMON ANODE

STYLE 2:
 CANCELLED

STYLE 3:
 PIN 1. NO CONNECTION
 2. ANODE
 3. ANODE
 4. NO CONNECTION
 5. ANODE
 6. NO CONNECTION
 7. ANODE
 8. ANODE
 9. ANODE
 10. NO CONNECTION
 11. ANODE
 12. ANODE
 13. NO CONNECTION
 14. COMMON CATHODE

STYLE 4:
 PIN 1. NO CONNECTION
 2. CATHODE
 3. CATHODE
 4. NO CONNECTION
 5. CATHODE
 6. NO CONNECTION
 7. CATHODE
 8. CATHODE
 9. CATHODE
 10. NO CONNECTION
 11. CATHODE
 12. CATHODE
 13. NO CONNECTION
 14. COMMON ANODE

STYLE 5:
 PIN 1. COMMON CATHODE
 2. ANODE/CATHODE
 3. ANODE/CATHODE
 4. ANODE/CATHODE
 5. ANODE/CATHODE
 6. NO CONNECTION
 7. COMMON ANODE
 8. COMMON CATHODE
 9. ANODE/CATHODE
 10. ANODE/CATHODE
 11. ANODE/CATHODE
 12. ANODE/CATHODE
 13. NO CONNECTION
 14. COMMON ANODE

STYLE 6:
 PIN 1. CATHODE
 2. CATHODE
 3. CATHODE
 4. CATHODE
 5. CATHODE
 6. CATHODE
 7. CATHODE
 8. ANODE
 9. ANODE
 10. ANODE
 11. ANODE
 12. ANODE
 13. ANODE
 14. ANODE

STYLE 7:
 PIN 1. ANODE/CATHODE
 2. COMMON ANODE
 3. COMMON CATHODE
 4. ANODE/CATHODE
 5. ANODE/CATHODE
 6. ANODE/CATHODE
 7. ANODE/CATHODE
 8. ANODE/CATHODE
 9. ANODE/CATHODE
 10. ANODE/CATHODE
 11. COMMON CATHODE
 12. COMMON ANODE
 13. ANODE/CATHODE
 14. ANODE/CATHODE

STYLE 8:
 PIN 1. COMMON CATHODE
 2. ANODE/CATHODE
 3. ANODE/CATHODE
 4. NO CONNECTION
 5. ANODE/CATHODE
 6. ANODE/CATHODE
 7. COMMON ANODE
 8. COMMON ANODE
 9. ANODE/CATHODE
 10. ANODE/CATHODE
 11. NO CONNECTION
 12. ANODE/CATHODE
 13. ANODE/CATHODE
 14. COMMON CATHODE

DOCUMENT NUMBER:	98ASB42565B	Electronic versions are uncontrolled except when accessed directly from the Document Repository. Printed versions are uncontrolled except when stamped "CONTROLLED COPY" in red.
DESCRIPTION:	SOIC-14 NB	PAGE 2 OF 2

onsemi and **ONSEMI** are trademarks of Semiconductor Components Industries, LLC dba **onsemi** or its subsidiaries in the United States and/or other countries. **onsemi** reserves the right to make changes without further notice to any products herein. **onsemi** makes no warranty, representation or guarantee regarding the suitability of its products for any particular purpose, nor does **onsemi** assume any liability arising out of the application or use of any product or circuit, and specifically disclaims any and all liability, including without limitation special, consequential or incidental damages. **onsemi** does not convey any license under its patent rights nor the rights of others.

MECHANICAL CASE OUTLINE

PACKAGE DIMENSIONS

ON Semiconductor®



SCALE 2:1

Micro8 CASE 846A-02 ISSUE K

DATE 16 JUL 2020



TOP VIEW

NOTE 3



SIDE VIEW



END VIEW

NOTES:

1. DIMENSIONING AND TOLERANCING PER ASME Y14.5M, 2009.
2. CONTROLLING DIMENSION: MILLIMETERS
3. DIMENSION *b* DOES NOT INCLUDE DAMBAR PROTRUSION. ALLOWABLE PROTRUSION SHALL BE 0.10 mm IN EXCESS OF MAXIMUM MATERIAL CONDITION.
4. DIMENSIONS *D* AND *E* DO NOT INCLUDE MOLD FLASH, PROTRUSION OR GATE BURRS. MOLD FLASH, PROTRUSIONS, OR GATE BURRS SHALL NOT EXCEED 0.15 mm PER SIDE. DIMENSION *E* DOES NOT INCLUDE INTERLEAD FLASH OR PROTRUSION. INTERLEAD FLASH OR PROTRUSION SHALL NOT EXCEED 0.25 mm PER SIDE. DIMENSIONS *D* AND *E* ARE DETERMINED AT DATUM *F*.
5. DATUMS *A* AND *B* ARE TO BE DETERMINED AT DATUM *F*.
6. *A1* IS DEFINED AS THE VERTICAL DISTANCE FROM THE SEATING PLANE TO THE LOWEST POINT ON THE PACKAGE BODY.

$\phi 0.08$ (0.003) M C B S A S

DIM	MILLIMETERS		
	MIN.	NOM.	MAX.
A	---	---	1.10
A1	0.05	0.08	0.15
<i>b</i>	0.25	0.33	0.40
<i>c</i>	0.13	0.18	0.23
<i>D</i>	2.90	3.00	3.10
<i>E</i>	2.90	3.00	3.10
<i>e</i>	0.65 BSC		
<i>H_E</i>	4.75	4.90	5.05
<i>L</i>	0.40	0.55	0.70

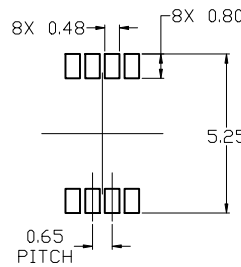

RECOMMENDED MOUNTING FOOTPRINT

For additional information on our Pb-Free strategy and soldering details, please download the ON Semiconductor Soldering and Mounting Techniques Reference Manual, SOLDERM/D.

GENERIC MARKING DIAGRAM*



- XXXX = Specific Device Code
- A = Assembly Location
- Y = Year
- W = Work Week
- = Pb-Free Package

(Note: Microdot may be in either location)

*This information is generic. Please refer to device data sheet for actual part marking. Pb-Free indicator, "G" or microdot "▪", may or may not be present. Some products may not follow the Generic Marking.

STYLE 1:

1. SOURCE
2. SOURCE
3. SOURCE
4. GATE
5. DRAIN
6. DRAIN
7. DRAIN
8. DRAIN

STYLE 2:

1. SOURCE 1
2. GATE 1
3. SOURCE 2
4. GATE 2
5. DRAIN 2
6. DRAIN 2
7. DRAIN 1
8. DRAIN 1

STYLE 3:

1. N-SOURCE
2. N-GATE
3. P-SOURCE
4. P-GATE
5. P-DRAIN
6. P-DRAIN
7. N-DRAIN
8. N-DRAIN

DOCUMENT NUMBER:	98ASB14087C	Electronic versions are uncontrolled except when accessed directly from the Document Repository. Printed versions are uncontrolled except when stamped "CONTROLLED COPY" in red.
DESCRIPTION:	MICRO8	PAGE 1 OF 1

ON Semiconductor and ON are trademarks of Semiconductor Components Industries, LLC dba ON Semiconductor or its subsidiaries in the United States and/or other countries. ON Semiconductor reserves the right to make changes without further notice to any products herein. ON Semiconductor makes no warranty, representation or guarantee regarding the suitability of its products for any particular purpose, nor does ON Semiconductor assume any liability arising out of the application or use of any product or circuit, and specifically disclaims any and all liability, including without limitation special, consequential or incidental damages. ON Semiconductor does not convey any license under its patent rights nor the rights of others.

MECHANICAL CASE OUTLINE PACKAGE DIMENSIONS



TSSOP-14 WB
CASE 948G
ISSUE C

DATE 17 FEB 2016

SCALE 2:1



NOTES:

- DIMENSIONING AND TOLERANCING PER ANSI Y14.5M, 1982.
- CONTROLLING DIMENSION: MILLIMETER.
- DIMENSION A DOES NOT INCLUDE MOLD FLASH, PROTRUSIONS OR GATE BURRS. MOLD FLASH OR GATE BURRS SHALL NOT EXCEED 0.15 (0.006) PER SIDE.
- DIMENSION B DOES NOT INCLUDE INTERLEAD FLASH OR PROTRUSION. INTERLEAD FLASH OR PROTRUSION SHALL NOT EXCEED 0.25 (0.010) PER SIDE.
- DIMENSION K DOES NOT INCLUDE DAMBAR PROTRUSION. ALLOWABLE DAMBAR PROTRUSION SHALL BE 0.08 (0.003) TOTAL IN EXCESS OF THE K DIMENSION AT MAXIMUM MATERIAL CONDITION.
- TERMINAL NUMBERS ARE SHOWN FOR REFERENCE ONLY.
- DIMENSION A AND B ARE TO BE DETERMINED AT DATUM PLANE -W-.

DIM	MILLIMETERS		INCHES	
	MIN	MAX	MIN	MAX
A	4.90	5.10	0.193	0.200
B	4.30	4.50	0.169	0.177
C	---	1.20	---	0.047
D	0.05	0.15	0.002	0.006
F	0.50	0.75	0.020	0.030
G	0.65 BSC		0.026 BSC	
H	0.50	0.60	0.020	0.024
J	0.09	0.20	0.004	0.008
J1	0.09	0.16	0.004	0.006
K	0.19	0.30	0.007	0.012
K1	0.19	0.25	0.007	0.010
L	6.40 BSC		0.252 BSC	
M	0°	8°	0°	8°

GENERIC MARKING DIAGRAM*



- A = Assembly Location
- L = Wafer Lot
- Y = Year
- W = Work Week
- = Pb-Free Package

(Note: Microdot may be in either location)

*This information is generic. Please refer to device data sheet for actual part marking. Pb-Free indicator, "G" or microdot "▪", may or may not be present. Some products may not follow the Generic Marking.

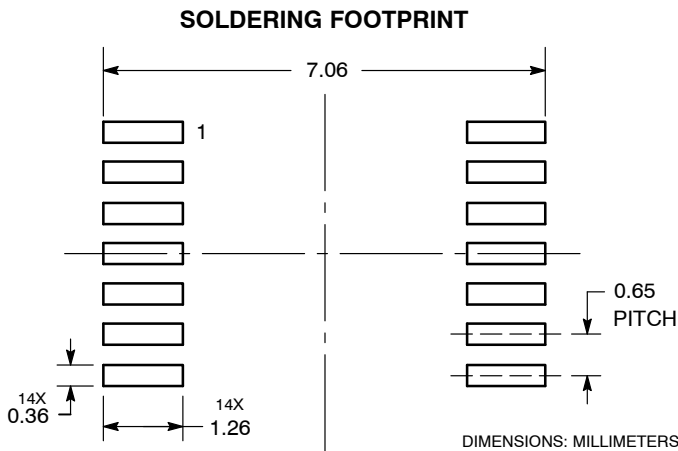

DOCUMENT NUMBER:	98ASH70246A	Electronic versions are uncontrolled except when accessed directly from the Document Repository. Printed versions are uncontrolled except when stamped "CONTROLLED COPY" in red.
DESCRIPTION:	TSSOP-14 WB	PAGE 1 OF 1

onsemi and onsemi are trademarks of Semiconductor Components Industries, LLC dba onsemi or its subsidiaries in the United States and/or other countries. onsemi reserves the right to make changes without further notice to any products herein. onsemi makes no warranty, representation or guarantee regarding the suitability of its products for any particular purpose, nor does onsemi assume any liability arising out of the application or use of any product or circuit, and specifically disclaims any and all liability, including without limitation special, consequential or incidental damages. onsemi does not convey any license under its patent rights nor the rights of others.

MECHANICAL CASE OUTLINE PACKAGE DIMENSIONS

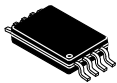

SCALE 2:1

TSSOP-8
CASE 948S
ISSUE C

DATE 20 JUN 2008

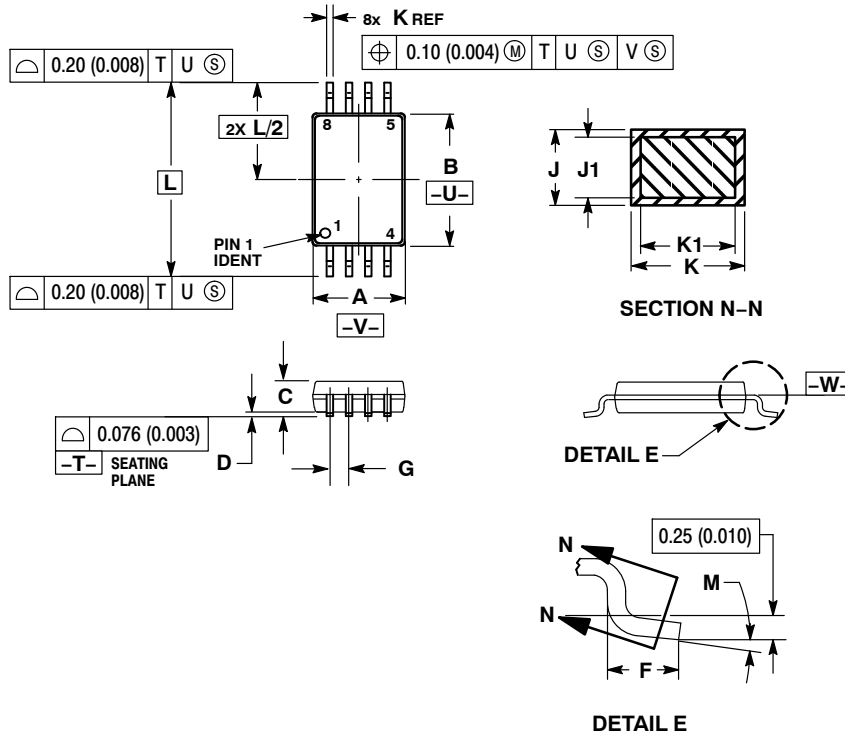

NOTES:

1. DIMENSIONING AND TOLERANCING PER ANSI Y14.5M, 1982.
2. CONTROLLING DIMENSION: MILLIMETER.
3. DIMENSION A DOES NOT INCLUDE MOLD FLASH, PROTRUSIONS OR GATE BURRS. MOLD FLASH OR GATE BURRS SHALL NOT EXCEED 0.15 (0.006) PER SIDE.
4. DIMENSION B DOES NOT INCLUDE INTERLEAD FLASH OR PROTRUSION. INTERLEAD FLASH OR PROTRUSION SHALL NOT EXCEED 0.25 (0.010) PER SIDE.
5. TERMINAL NUMBERS ARE SHOWN FOR REFERENCE ONLY.
6. DIMENSION A AND B ARE TO BE DETERMINED AT DATUM PLANE -W-.

DIM	MILLIMETERS		INCHES	
	MIN	MAX	MIN	MAX
A	2.90	3.10	0.114	0.122
B	4.30	4.50	0.169	0.177
C	---	1.10	---	0.043
D	0.05	0.15	0.002	0.006
F	0.50	0.70	0.020	0.028
G	0.65 BSC		0.026 BSC	
J	0.09	0.20	0.004	0.008
J1	0.09	0.16	0.004	0.006
K	0.19	0.30	0.007	0.012
K1	0.19	0.25	0.007	0.010
L	6.40 BSC		0.252 BSC	
M	0°	8°	0°	8°

GENERIC MARKING DIAGRAM*

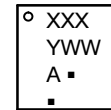

- XXX = Specific Device Code
- A = Assembly Location
- Y = Year
- WW = Work Week
- = Pb-Free Package

*This information is generic. Please refer to device data sheet for actual part marking. Pb-Free indicator, "G" or microdot "▪", may or may not be present. Some products may not follow the Generic Marking.

DOCUMENT NUMBER:	98AON00697D	Electronic versions are uncontrolled except when accessed directly from the Document Repository. Printed versions are uncontrolled except when stamped "CONTROLLED COPY" in red.
DESCRIPTION:	TSSOP-8	PAGE 1 OF 1

onsemi and ONSEMI are trademarks of Semiconductor Components Industries, LLC dba onsemi or its subsidiaries in the United States and/or other countries. onsemi reserves the right to make changes without further notice to any products herein. onsemi makes no warranty, representation or guarantee regarding the suitability of its products for any particular purpose, nor does onsemi assume any liability arising out of the application or use of any product or circuit, and specifically disclaims any and all liability, including without limitation special, consequential or incidental damages. onsemi does not convey any license under its patent rights nor the rights of others.

onsemi, **Onsemi**, and other names, marks, and brands are registered and/or common law trademarks of Semiconductor Components Industries, LLC dba "**onsemi**" or its affiliates and/or subsidiaries in the United States and/or other countries. **onsemi** owns the rights to a number of patents, trademarks, copyrights, trade secrets, and other intellectual property. A listing of **onsemi**'s product/patent coverage may be accessed at www.onsemi.com/site/pdf/Patent-Marking.pdf. **onsemi** reserves the right to make changes at any time to any products or information herein, without notice. The information herein is provided "as-is" and **onsemi** makes no warranty, representation or guarantee regarding the accuracy of the information, product features, availability, functionality, or suitability of its products for any particular purpose, nor does **onsemi** assume any liability arising out of the application or use of any product or circuit, and specifically disclaims any and all liability, including without limitation special, consequential or incidental damages. Buyer is responsible for its products and applications using **onsemi** products, including compliance with all laws, regulations and safety requirements or standards, regardless of any support or applications information provided by **onsemi**. "Typical" parameters which may be provided in **onsemi** data sheets and/or specifications can and do vary in different applications and actual performance may vary over time. All operating parameters, including "Typicals" must be validated for each customer application by customer's technical experts. **onsemi** does not convey any license under any of its intellectual property rights nor the rights of others. **onsemi** products are not designed, intended, or authorized for use as a critical component in life support systems or any FDA Class 3 medical devices or medical devices with a same or similar classification in a foreign jurisdiction or any devices intended for implantation in the human body. Should Buyer purchase or use **onsemi** products for any such unintended or unauthorized application, Buyer shall indemnify and hold **onsemi** and its officers, employees, subsidiaries, affiliates, and distributors harmless against all claims, costs, damages, and expenses, and reasonable attorney fees arising out of, directly or indirectly, any claim of personal injury or death associated with such unintended or unauthorized use, even if such claim alleges that **onsemi** was negligent regarding the design or manufacture of the part. **onsemi** is an Equal Opportunity/Affirmative Action Employer. This literature is subject to all applicable copyright laws and is not for resale in any manner.

ADDITIONAL INFORMATION

TECHNICAL PUBLICATIONS:

Technical Library: www.onsemi.com/design/resources/technical-documentation
onsemi Website: www.onsemi.com

ONLINE SUPPORT: www.onsemi.com/support

For additional information, please contact your local Sales Representative at www.onsemi.com/support/sales