

# NL17SG34

## Single Buffer

The NL17SG34 MiniGate™ is an advanced high-speed CMOS Buffer in ultra-small footprint.

The NL17SG34 input structures provides protection when voltages up to 4.6 V are applied.

### Features

- Wide Operating  $V_{CC}$  Range: 0.9 V to 3.6 V
- High Speed:  $t_{PD} = 2.3$  ns (Typ) at  $V_{CC} = 3.0$  V,  $C_L = 15$  pF
- Low Power Dissipation:  $I_{CC} = 0.5$   $\mu$ A (Max) at  $T_A = 25^\circ$ C
- 4.6 V Overvoltage Tolerant (OVT) Input Pins
- Ultra-Small Packages
- These are Pb-Free and Halide-Free Devices

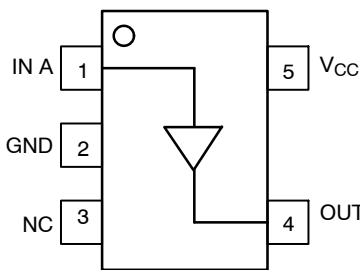

Figure 1. SOT-953  
(Top Thru View)

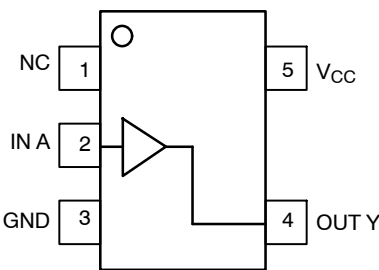

Figure 2. SC-88A/TSOP-5  
(Top View)

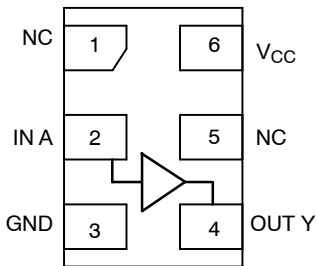

Figure 3. UDFN  
(Top View)

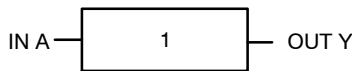

Figure 4. Logic Symbol



ON Semiconductor®

<http://onsemi.com>

### MARKING DIAGRAMS



SOT-953  
CASE 527AE

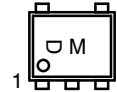

D = Specific Device Code  
(D with 90 degree clockwise rotation)



UDFN6  
1.0 x 1.0  
CASE 517BX



UDFN6  
1.45 x 1.0  
CASE 517AQ



SC-88A  
DF SUFFIX  
CASE 419A

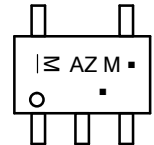

TSOP-5  
DT SUFFIX  
CASE 483

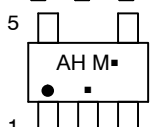

M = Date Code\*  
▪ = Pb-Free Package

(Note: Microdot may be in either location)

\*Date Code orientation and/or position may vary depending upon manufacturing location.

### PIN ASSIGNMENT

	SOT-953	SC88A/TSOP5	UDFN6
1	IN A	NC	NC
2	GND	IN A	IN A
3	NC	GND	GND
4	OUT Y	OUT Y	OUT Y
5	$V_{CC}$	$V_{CC}$	NC
6			$V_{CC}$

### FUNCTION TABLE

A Input	Y Output
L	L
H	H

### ORDERING INFORMATION

See detailed ordering and shipping information on page 5 of this data sheet.

# NL17SG34

## MAXIMUM RATINGS

Symbol	Parameter	Value	Unit
$V_{CC}$	DC Supply Voltage	-0.5 to +5.5	V
$V_{IN}$	DC Input Voltage	-0.5 to +4.6	V
$V_{OUT}$	DC Output Voltage Output at High or Low State Power-Down Mode ( $V_{CC} = 0$ V)	-0.5 to $V_{CC} + 0.5$ -0.5 to +4.6	V
$I_{IK}$	DC Input Diode Current $V_{IN} < GND$	-20	mA
$I_{OK}$	DC Output Diode Current $V_{OUT} < GND$	-20	mA
$I_{OUT}$	DC Output Source/Sink Current	$\pm 20$	mA
$I_{CC}$	DC Supply Current per Supply Pin	$\pm 20$	mA
$I_{GND}$	DC Ground Current per Ground Pin	$\pm 20$	mA
$T_{STG}$	Storage Temperature Range	-65 to +150	$^{\circ}C$
$T_L$	Lead Temperature, 1 mm from Case for 10 Seconds	260	$^{\circ}C$
$T_J$	Junction Temperature Under Bias	+150	$^{\circ}C$
MSL	Moisture Sensitivity	Level 1	
$F_R$	Flammability Rating Oxygen Index: 28 to 34	UL 94 V-0 @ 0.125 in	
$V_{ESD}$	ESD Withstand Voltage Human Body Model (Note 2) Machine Model (Note 3)	>2000 >100	V
$I_{LATCHUP}$	Latchup Performance Above $V_{CC}$ and Below GND at 125 $^{\circ}C$ (Note 4)	$\pm 100$	mA

Stresses exceeding those listed in the Maximum Ratings table may damage the device. If any of these limits are exceeded, device functionality should not be assumed, damage may occur and reliability may be affected.

1. Measured with minimum pad spacing on an FR4 board, using 10 mm-by-1 inch, 2-ounce copper trace with no air flow.
2. Tested to EIA/JESD22-A114-A.
3. Tested to EIA/JESD22-A115-A.
4. Tested to EIA/JESD78.

## RECOMMENDED OPERATING CONDITIONS

Symbol	Characteristics	Min	Max	Unit
$V_{CC}$	Positive DC Supply Voltage	0.9	3.6	V
$V_{IN}$	Digital Input Voltage	0.0	3.6	V
$V_{OUT}$	Output Voltage Output at High or Low State Power-Down Mode ( $V_{CC} = 0$ V)	0.0 0.0	$V_{CC}$ 3.6	V
$T_A$	Operating Temperature Range	-55	+125	$^{\circ}C$
$\Delta t / \Delta V$	Input Transition Rise or Fall Rate $V_{CC} = 3.3$ V $\pm$ 0.3 V	0	10	ns/V

Functional operation above the stresses listed in the Recommended Operating Ranges is not implied. Extended exposure to stresses beyond the Recommended Operating Ranges limits may affect device reliability.

# NL17SG34

## DC ELECTRICAL CHARACTERISTICS

Symbol	Parameter	Conditions	V <sub>CC</sub> (V)	T <sub>A</sub> = 25°C		T <sub>A</sub> = -55°C to +125°C		Unit
				Min	Max	Min	Max	
V <sub>IH</sub>	High-Level Input Voltage		0.9	V <sub>CC</sub>		V <sub>CC</sub>		V
			1.1 to 1.3	0.7xV <sub>CC</sub>		0.7xV <sub>CC</sub>		
			1.4 to 1.6	0.65xV <sub>CC</sub>		0.65xV <sub>CC</sub>		
			1.65 to 1.95	0.65xV <sub>CC</sub>		0.65xV <sub>CC</sub>		
			2.3 to 2.7	1.7		1.7		
			3.0 to 3.6	2.0		2.0		
V <sub>IL</sub>	Low-Level Input Voltage		0.9		GND		GND	V
			1.1 to 1.3		0.3xV <sub>CC</sub>		0.3xV <sub>CC</sub>	
			1.4 to 1.6		0.35xV <sub>CC</sub>		0.35xV <sub>CC</sub>	
			1.65 to 1.95		0.35xV <sub>CC</sub>		0.35xV <sub>CC</sub>	
			2.3 to 2.7		0.7		0.7	
			3.0 to 3.6		0.8		0.8	
V <sub>OH</sub>	High-Level Output Voltage	V <sub>IN</sub> = V <sub>IH</sub> or V <sub>IL</sub>	I <sub>OH</sub> = -20 μA	0.9	0.75		0.75	V
			I <sub>OH</sub> = -0.3 mA	1.1 to 1.3	0.75xV <sub>CC</sub>		0.75xV <sub>CC</sub>	
			I <sub>OH</sub> = -1.7 mA	1.4 to 1.6	0.75xV <sub>CC</sub>		0.75xV <sub>CC</sub>	
			I <sub>OH</sub> = -3.0 mA	1.65 to 1.95	V <sub>CC</sub> -0.45		V <sub>CC</sub> -0.45	
			I <sub>OH</sub> = -4.0 mA	2.3 to 2.7	2.0		2.0	
			I <sub>OH</sub> = -8.0 mA	3.0 to 3.6	2.48		2.48	
V <sub>OL</sub>	Low-Level Output Voltage	V <sub>IN</sub> = V <sub>IH</sub> or V <sub>IL</sub>	I <sub>OL</sub> = 20 μA	0.9		0.1	0.1	V
			I <sub>OL</sub> = 0.3 mA	1.1 to 1.3		0.25xV <sub>CC</sub>	0.25xV <sub>CC</sub>	
			I <sub>OL</sub> = 1.7 mA	1.4 to 1.6		0.25xV <sub>CC</sub>	0.25xV <sub>CC</sub>	
			I <sub>OL</sub> = 3.0 mA	1.65 to 1.95		0.45	0.45	
			I <sub>OL</sub> = 4.0 mA	2.3 to 2.7		0.4	0.4	
			I <sub>OL</sub> = 8.0 mA	3.0 to 3.6		0.4	0.4	
I <sub>IN</sub>	Input Leakage Current	0 ≤ V <sub>IN</sub> ≤ 3.6 V	0 to 3.6		±0.1		±1.0	μA
I <sub>CC</sub>	Quiescent Supply Current	V <sub>IN</sub> = V <sub>CC</sub> or GND	3.6		0.5		10.0	μA

Product parametric performance is indicated in the Electrical Characteristics for the listed test conditions, unless otherwise noted. Product performance may not be indicated by the Electrical Characteristics if operated under different conditions.

# NL17SG34

## AC ELECTRICAL CHARACTERISTICS Input $t_r = t_f = 3.0$ ns

Symbol	Parameter	Test Condition	$V_{CC}$ (V)	$T_A = 25^\circ\text{C}$			$T_A = -55^\circ\text{C to } +125^\circ\text{C}$		Unit
				Min	Typ	Max	Min	Max	
$t_{PLH}$ , $t_{PHL}$	Propagation Delay, A to Y	$C_L = 10$ pF, $R_L = 1$ M $\Omega$	0.9	–	12.6	15.3	–	19.0	ns
			1.1 to 1.3	–	8.7	13.4	–	15.2	
			1.4 to 1.6	–	4.9	8.5	–	10.0	
			1.65 to 1.95	–	3.8	6.2	–	6.7	
			2.3 to 2.7	–	2.6	3.9	–	4.4	
			3.0 to 3.6	–	2.1	3.1	–	3.7	
		$C_L = 15$ pF, $R_L = 1$ M $\Omega$	0.9	–	13.0	16.6	–	20.8	ns
			1.1 to 1.3	–	8.0	12.5	–	15.7	
			1.4 to 1.6	–	5.4	9.3	–	11.2	
			1.65 to 1.95	–	4.2	6.9	–	7.1	
			2.3 to 2.7	–	2.8	4.4	–	5.0	
			3.0 to 3.6	–	2.3	3.4	–	3.9	
		$C_L = 30$ pF, $R_L = 1$ M $\Omega$	0.9	–	14.5	17.6	–	22.4	ns
			1.1 to 1.3	–	9.5	13.5	–	18.8	
			1.4 to 1.6	–	7.4	11.1	–	15.9	
			1.65 to 1.95	–	5.6	9.2	–	9.6	
			2.3 to 2.7	–	3.7	5.7	–	6.1	
			3.0 to 3.6	–	2.9	4.4	–	4.8	
$C_{IN}$	Input Capacitance		0 to 3.6		3	–	–	pF	
$C_{PD}$	Power Dissipation Capacitance (Note 5)	$f = 10$ MHz	0.9 to 3.6	–	4	–	–	pF	

Product parametric performance is indicated in the Electrical Characteristics for the listed test conditions, unless otherwise noted. Product performance may not be indicated by the Electrical Characteristics if operated under different conditions.

5.  $C_{PD}$  is defined as the value of the internal equivalent capacitance which is calculated from the operating current consumption without load. Average operating current can be obtained by the equation:  $I_{CC(OPR)} = C_{PD} \cdot V_{CC} \cdot f_{in} + I_{CC}$ .  $C_{PD}$  is used to determine the no-load dynamic power consumption;  $P_D = C_{PD} \cdot V_{CC}^2 \cdot f_{in} + I_{CC} \cdot V_{CC}$ .

## NL17SG34

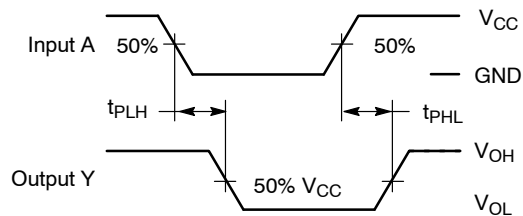
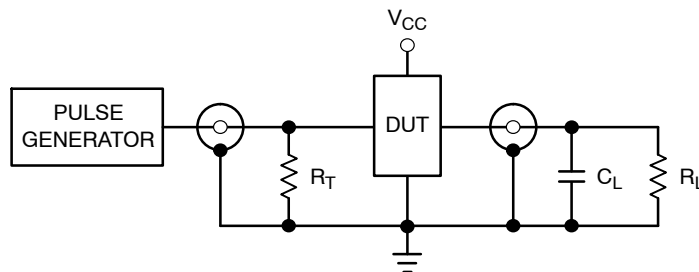

Figure 5. Switching Waveforms



$R_T = Z_{OUT}$  of pulse generator (typically 50  $\Omega$ )

Figure 6. Test Circuit

### ORDERING INFORMATION

Device	Package	Shipping <sup>†</sup>
NL17SG34P5T5G	SOT-953 (Pb-Free)	8000 / Tape & Reel
NL17SG34DFT2G	SC-88A (Pb-Free)	3000 / Tape & Reel
NL17SG34DTT1G*	TSOP-5 (Pb-Free)	3000 / Tape & Reel
NL17SG34AMUTCG*	UDFN6 1.45x1 mm (Pb-Free)	3000 / Tape & Reel
NL17SG34CMUTCG*	UDFN6 1x1 mm (Pb-Free)	3000 / Tape & Reel

<sup>†</sup>For information on tape and reel specifications, including part orientation and tape sizes, please refer to our Tape and Reel Packaging Specifications Brochure, BRD8011/D.

\*In Development

# MECHANICAL CASE OUTLINE PACKAGE DIMENSIONS



SCALE 2:1

## SC-88A (SC-70-5/SOT-353) CASE 419A-02 ISSUE M

DATE 11 APR 2023

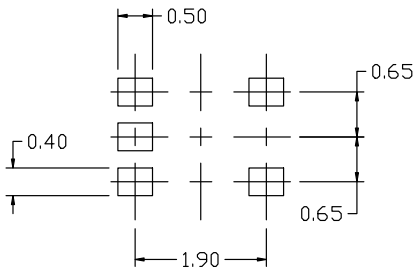

RECOMMENDED  
MOUNTING FOOTPRINT

\* For additional information on our Pb-Free strategy and soldering details, please download the ON Semiconductor Soldering and Mounting Techniques Reference Manual, SOLDERM/D.

### NOTES:

1. DIMENSIONING AND TOLERANCING PER ANSI Y14.5M, 1982.
2. CONTROLLING DIMENSION: MILLIMETERS
3. 419A-01 OBSOLETE. NEW STANDARD 419A-02
4. DIMENSIONS D AND E1 DO NOT INCLUDE MOLD FLASH, PROTRUSIONS, OR GATE BURRS. MOLD FLASH, PROTRUSIONS, OR GATE BURRS SHALL NOT EXCEED 0.1016MM PER SIDE.

DIM	MILLIMETERS		
	MIN.	NOM.	MAX.
A	0.80	0.95	1.10
A1	---	---	0.10
A3	0.20 REF		
b	0.10	0.20	0.30
c	0.10	---	0.25
D	1.80	2.00	2.20
E	2.00	2.10	2.20
E1	1.15	1.25	1.35
e	0.65 BSC		
L	0.10	0.15	0.30

### GENERIC MARKING DIAGRAM\*



\*This information is generic. Please refer to device data sheet for actual part marking. Pb-Free indicator, "G" or microdot "■", may or may not be present. Some products may not follow the Generic Marking.

XXX = Specific Device Code

M = Date Code

■ = Pb-Free Package

(Note: Microdot may be in either location)

#### STYLE 1:

1. BASE
2. EMITTER
3. BASE
4. COLLECTOR
5. COLLECTOR

#### STYLE 2:

1. ANODE
2. EMITTER
3. BASE
4. COLLECTOR
5. CATHODE

#### STYLE 3:

1. ANODE 1
2. N/C
3. ANODE 2
4. CATHODE 2
5. CATHODE 1

#### STYLE 4:

1. SOURCE 1
2. DRAIN 1/2
3. SOURCE 1
4. GATE 1
5. GATE 2

#### STYLE 5:

1. CATHODE
2. COMMON ANODE
3. CATHODE 2
4. CATHODE 3
5. CATHODE 4

#### STYLE 6:

1. EMITTER 2
2. BASE 2
3. EMITTER 1
4. COLLECTOR
5. COLLECTOR 2/BASE 1

#### STYLE 7:

1. BASE
2. EMITTER
3. BASE
4. COLLECTOR
5. COLLECTOR

#### STYLE 8:

1. CATHODE
2. COLLECTOR
3. N/C
4. BASE
5. EMITTER

#### STYLE 9:

1. ANODE
2. CATHODE
3. ANODE
4. ANODE
5. ANODE

Note: Please refer to datasheet for style callout. If style type is not called out in the datasheet refer to the device datasheet pinout or pin assignment.

<b>DOCUMENT NUMBER:</b>	<b>98ASB42984B</b>	Electronic versions are uncontrolled except when accessed directly from the Document Repository. Printed versions are uncontrolled except when stamped "CONTROLLED COPY" in red.
<b>DESCRIPTION:</b>	<b>SC-88A (SC-70-5/SOT-353)</b>	<b>PAGE 1 OF 1</b>

onsemi and ONSEMI are trademarks of Semiconductor Components Industries, LLC dba onsemi or its subsidiaries in the United States and/or other countries. onsemi reserves the right to make changes without further notice to any products herein. onsemi makes no warranty, representation or guarantee regarding the suitability of its products for any particular purpose, nor does onsemi assume any liability arising out of the application or use of any product or circuit, and specifically disclaims any and all liability, including without limitation special, consequential or incidental damages. onsemi does not convey any license under its patent rights nor the rights of others.

# MECHANICAL CASE OUTLINE PACKAGE DIMENSIONS



SCALE 4:1

UDFN6, 1.45x1.0, 0.5P  
CASE 517AQ  
ISSUE O

DATE 15 MAY 2008

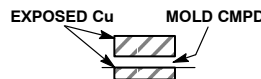
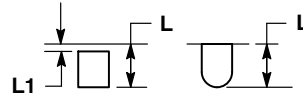

- NOTES:
1. DIMENSIONING AND TOLERANCING PER ASME Y14.5M, 1994.
  2. CONTROLLING DIMENSION: MILLIMETERS.
  3. DIMENSION b APPLIES TO PLATED TERMINAL AND IS MEASURED BETWEEN 0.15 AND 0.30 mm FROM THE TERMINAL TIP.

MILLIMETERS		
DIM	MIN	MAX
A	0.45	0.55
A1	0.00	0.05
A2	0.07	REF
b	0.20	0.30
D	1.45	BSC
E	1.00	BSC
e	0.50	BSC
L	0.30	0.40
L1	---	0.15

### MOUNTING FOOTPRINT

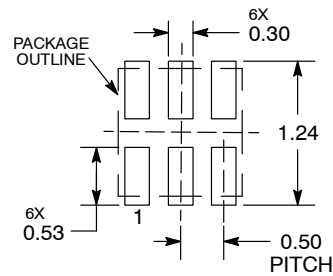

DIMENSIONS: MILLIMETERS

\*For additional information on our Pb-Free strategy and soldering details, please download the ON Semiconductor Soldering and Mounting Techniques Reference Manual, SOLDERRM/D.

### GENERIC MARKING DIAGRAM\*



X = Specific Device Code  
M = Date Code

\*This information is generic. Please refer to device data sheet for actual part marking. Pb-Free indicator, "G" or microdot "▪", may or may not be present.

<b>DOCUMENT NUMBER:</b>	<b>98AON30313E</b>	Electronic versions are uncontrolled except when accessed directly from the Document Repository. Printed versions are uncontrolled except when stamped "CONTROLLED COPY" in red.
<b>DESCRIPTION:</b>	<b>UDFN6, 1.45x1.0, 0.5P</b>	<b>PAGE 1 OF 1</b>

onsemi and ONSEMI are trademarks of Semiconductor Components Industries, LLC dba onsemi or its subsidiaries in the United States and/or other countries. onsemi reserves the right to make changes without further notice to any products herein. onsemi makes no warranty, representation or guarantee regarding the suitability of its products for any particular purpose, nor does onsemi assume any liability arising out of the application or use of any product or circuit, and specifically disclaims any and all liability, including without limitation special, consequential or incidental damages. onsemi does not convey any license under its patent rights nor the rights of others.

# MECHANICAL CASE OUTLINE PACKAGE DIMENSIONS

ON Semiconductor®



SCALE 4:1

**SOT-953**  
CASE 527AE  
ISSUE E

DATE 02 AUG 2011

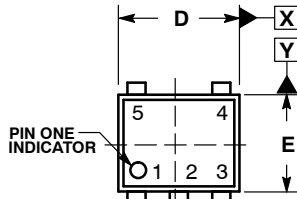

TOP VIEW

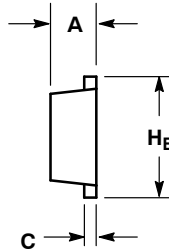

SIDE VIEW

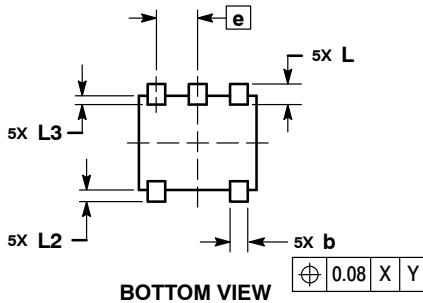

BOTTOM VIEW

**SOLDERING FOOTPRINT\***

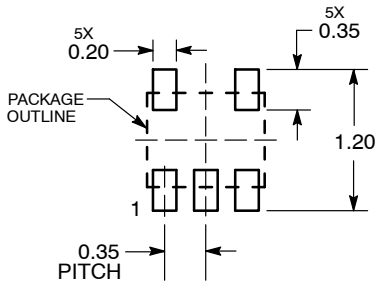

DIMENSIONS: MILLIMETERS

NOTES:

1. DIMENSIONING AND TOLERANCING PER ASME Y14.5M, 1994.
2. CONTROLLING DIMENSION: MILLIMETERS
3. MAXIMUM LEAD THICKNESS INCLUDES LEAD FINISH. MINIMUM LEAD THICKNESS IS THE MINIMUM THICKNESS OF THE BASE MATERIAL.
4. DIMENSIONS D AND E DO NOT INCLUDE MOLD FLASH, PROTRUSIONS, OR GATE BURRS.

DIM	MILLIMETERS		
	MIN	NOM	MAX
A	0.34	0.37	0.40
b	0.10	0.15	0.20
C	0.07	0.12	0.17
D	0.95	1.00	1.05
E	0.75	0.80	0.85
e	0.35 BSC		
H <sub>E</sub>	0.95	1.00	1.05
L	0.175 REF		
L2	0.05	0.10	0.15
L3	---	---	0.15

**GENERIC MARKING DIAGRAM\***

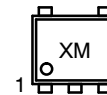

X = Specific Device Code  
M = Month Code

\*This information is generic. Please refer to device data sheet for actual part marking.

Pb-Free indicator, "G" or microdot "▪", may or may not be present.

\*For additional information on our Pb-Free strategy and soldering details, please download the ON Semiconductor Soldering and Mounting Techniques Reference Manual, SOLDERRM/D.

<b>DOCUMENT NUMBER:</b>	<b>98AON26457D</b>	Electronic versions are uncontrolled except when accessed directly from the Document Repository. Printed versions are uncontrolled except when stamped "CONTROLLED COPY" in red.
<b>DESCRIPTION:</b>	<b>SOT-953</b>	<b>PAGE 1 OF 1</b>

ON Semiconductor and ON are trademarks of Semiconductor Components Industries, LLC dba ON Semiconductor or its subsidiaries in the United States and/or other countries. ON Semiconductor reserves the right to make changes without further notice to any products herein. ON Semiconductor makes no warranty, representation or guarantee regarding the suitability of its products for any particular purpose, nor does ON Semiconductor assume any liability arising out of the application or use of any product or circuit, and specifically disclaims any and all liability, including without limitation special, consequential or incidental damages. ON Semiconductor does not convey any license under its patent rights nor the rights of others.



**onsemi**, **Onsemi**, and other names, marks, and brands are registered and/or common law trademarks of Semiconductor Components Industries, LLC dba "**onsemi**" or its affiliates and/or subsidiaries in the United States and/or other countries. **onsemi** owns the rights to a number of patents, trademarks, copyrights, trade secrets, and other intellectual property. A listing of **onsemi**'s product/patent coverage may be accessed at [www.onsemi.com/site/pdf/Patent-Marking.pdf](http://www.onsemi.com/site/pdf/Patent-Marking.pdf). **onsemi** reserves the right to make changes at any time to any products or information herein, without notice. The information herein is provided "as-is" and **onsemi** makes no warranty, representation or guarantee regarding the accuracy of the information, product features, availability, functionality, or suitability of its products for any particular purpose, nor does **onsemi** assume any liability arising out of the application or use of any product or circuit, and specifically disclaims any and all liability, including without limitation special, consequential or incidental damages. Buyer is responsible for its products and applications using **onsemi** products, including compliance with all laws, regulations and safety requirements or standards, regardless of any support or applications information provided by **onsemi**. "Typical" parameters which may be provided in **onsemi** data sheets and/or specifications can and do vary in different applications and actual performance may vary over time. All operating parameters, including "Typicals" must be validated for each customer application by customer's technical experts. **onsemi** does not convey any license under any of its intellectual property rights nor the rights of others. **onsemi** products are not designed, intended, or authorized for use as a critical component in life support systems or any FDA Class 3 medical devices or medical devices with a same or similar classification in a foreign jurisdiction or any devices intended for implantation in the human body. Should Buyer purchase or use **onsemi** products for any such unintended or unauthorized application, Buyer shall indemnify and hold **onsemi** and its officers, employees, subsidiaries, affiliates, and distributors harmless against all claims, costs, damages, and expenses, and reasonable attorney fees arising out of, directly or indirectly, any claim of personal injury or death associated with such unintended or unauthorized use, even if such claim alleges that **onsemi** was negligent regarding the design or manufacture of the part. **onsemi** is an Equal Opportunity/Affirmative Action Employer. This literature is subject to all applicable copyright laws and is not for resale in any manner.

## ADDITIONAL INFORMATION

### TECHNICAL PUBLICATIONS:

Technical Library: [www.onsemi.com/design/resources/technical-documentation](http://www.onsemi.com/design/resources/technical-documentation)  
onsemi Website: [www.onsemi.com](http://www.onsemi.com)

### ONLINE SUPPORT: [www.onsemi.com/support](http://www.onsemi.com/support)

For additional information, please contact your local Sales Representative at [www.onsemi.com/support/sales](http://www.onsemi.com/support/sales)