

Multifunction quad power amplifier with built-in diagnostics features

Datasheet – production data

Features

- Multipower BCD technology
- DMOS power output
- High output power capability 4 x 25 W / 4 Ω @ 14.4 V, 1 kHz, 10 % THD, 4 x 35 W EIAJ
- Max. output power 4 x 60 W / 2 Ω
- Full I²C bus driving:
 - Standby
 - Independent front/rear soft play/mute
 - Selectable gain 26 dB - 12 dB (for low noise line output function)
 - I²C bus digital diagnostics
- Full fault protection
- DC offset detection
- Four independent short circuit protection
- Clipping detector
- ESD protection

Description

The TDA7561 is a BCD technology quad bridge type of car radio amplifier in Flexiwatt25 package specially intended for car radio applications.

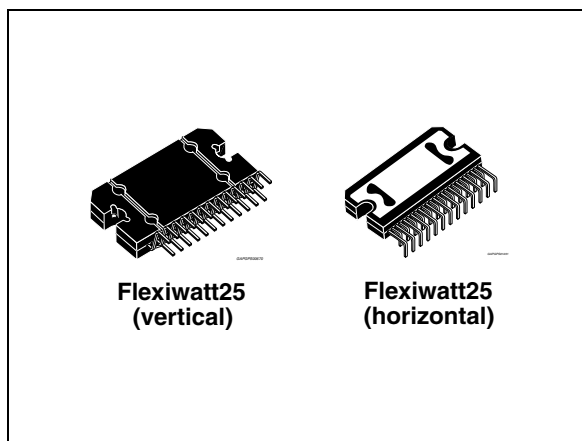

Thanks to the DMOS output stage the TDA7561 has a very low distortion allowing a clear powerful sound.

This device is equipped with a full diagnostics array that communicates the status of each speaker through the I²C bus. The possibility to control the configuration and behaviour of the device by means of the I²C bus makes TDA7561 a very flexible machine.

Table 1. Device summary

Order code	Package	Packing
TDA7561	Flexiwatt25 (vertical)	Tube
TDA7561H	Flexiwatt25 (horizontal)	Tube

Contents

1	Block diagram and test/application diagram	5
2	Pins description	6
3	Electrical specifications	7
3.1	Absolute maximum ratings	7
3.2	Thermal data	7
3.3	Electrical characteristics	7
3.4	Electrical characteristics curves	10
4	Diagnostics functional description	12
4.1	Turn-on diagnostic	12
4.2	Permanent diagnostics	14
4.3	Output DC offset detection	15
5	Multiple faults	16
5.1	Faults availability	16
6	I2C bus	17
6.1	I2C programming/reading sequence	17
6.2	I2C bus interface	17
6.2.1	Data validity	17
6.2.2	Start and stop conditions	17
6.2.3	Byte format	17
6.2.4	Acknowledge	18
7	Software specifications	19
8	Examples of bytes sequence	23
9	Package information	24
10	Revision history	26

List of tables

Table 1.	Device summary	1
Table 2.	Absolute maximum ratings	7
Table 3.	Thermal data	7
Table 4.	Electrical characteristics	7
Table 5.	Double fault table for turn-on diagnostic	16
Table 6.	IB1	19
Table 7.	IB2	20
Table 8.	DB1	20
Table 9.	DB2	21
Table 10.	DB3	21
Table 11.	DB4	22
Table 12.	Document revision history	26

List of figures

Figure 1.	Block diagram	5
Figure 2.	Test and application diagram	5
Figure 3.	Pins connection diagram (top view)	6
Figure 4.	Quiescent current vs. supply voltage	10
Figure 5.	Output power vs. supply voltage, $R_L = 2 \Omega$	10
Figure 6.	Output power vs. supply voltage, $R_L = 4 \Omega$	10
Figure 7.	Distortion vs output power, $R_L = 2 \Omega$	10
Figure 8.	Distortion vs output power, $R_L = 4 \Omega$	10
Figure 9.	Distortion vs. frequency, $R_L = 2 \Omega$	10
Figure 10.	Distortion vs. frequency, $R_L = 4 \Omega$	11
Figure 11.	Crosstalk vs. frequency	11
Figure 12.	Supply voltage rejection vs. frequency	11
Figure 13.	Power dissipation and efficiency vs. output power (4 Ω , SINE)	11
Figure 14.	Power dissipation vs. average output power (audio program simulation, 4 Ω)	11
Figure 15.	Power dissipation vs. average output power (audio program simulation, 2 Ω)	11
Figure 16.	Turn-on diagnostic: working principle	12
Figure 17.	SVR and output behaviour (case 1: without turn-on diagnostic)	12
Figure 18.	SVR and output pin behaviour (case 2: with turn-on diagnostic)	13
Figure 19.	Short circuit detection thresholds	13
Figure 20.	Load detection thresholds - high gain setting	13
Figure 21.	Load detection threshold - low gain setting	13
Figure 22.	Restart timing without diagnostic enable (permanent) - Each 1 mS time, a sampling of the fault is done	14
Figure 23.	Restart timing with diagnostic enable (permanent)	14
Figure 24.	Data validity on the I ² C bus	18
Figure 25.	Timing diagram on the I ² C bus	18
Figure 26.	Acknowledge on the I ² C bus	18
Figure 27.	Flexivatt25 (vertical) mechanical data and package dimensions	24
Figure 28.	Flexivatt25 (horizontal) mechanical data and package dimensions	25

1 Block diagram and test/application diagram

Figure 1. Block diagram

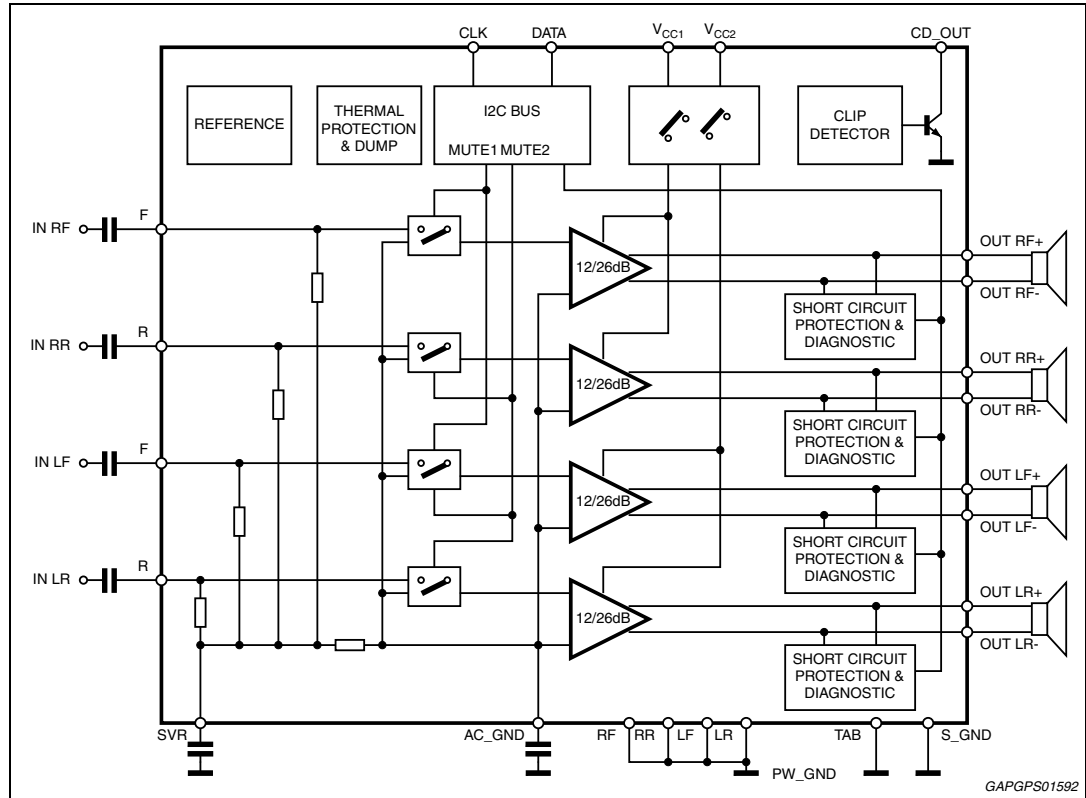
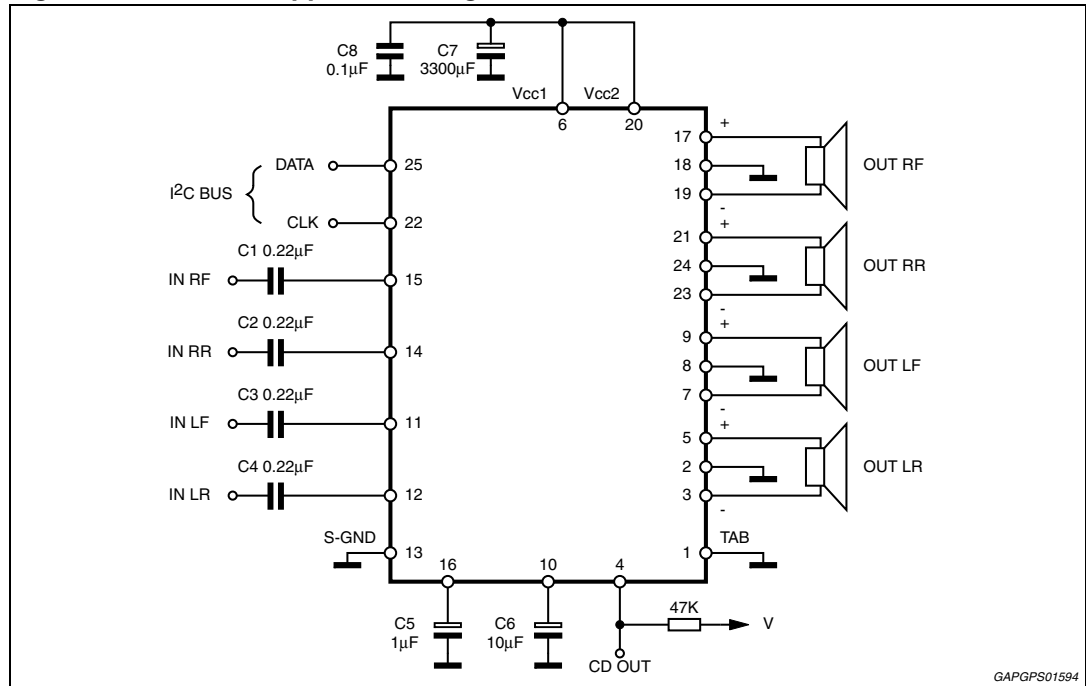
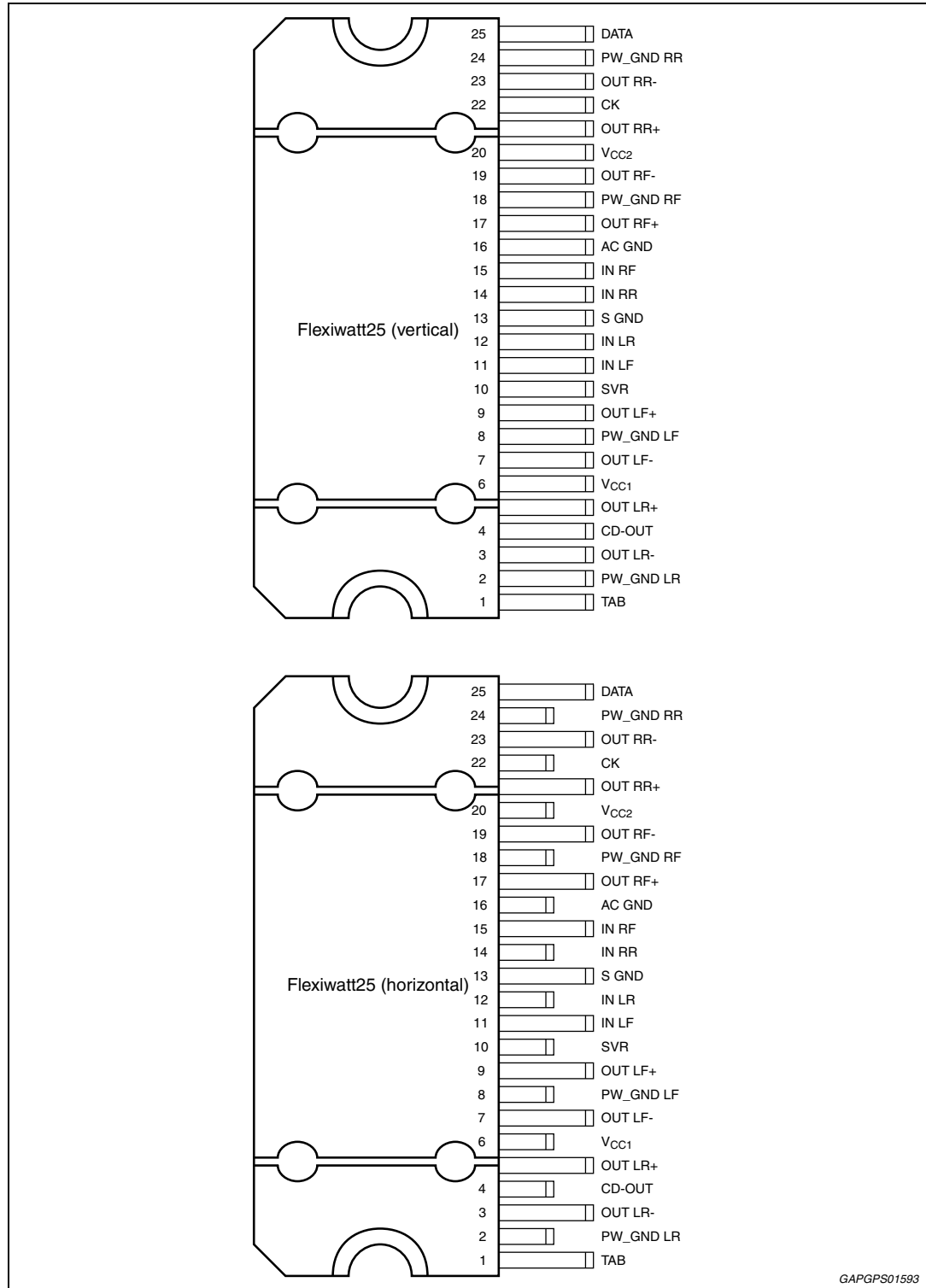

Figure 2. Test and application diagram



2 Pins description

Figure 3. Pins connection diagram (top view)



3 Electrical specifications

3.1 Absolute maximum ratings

Table 2. Absolute maximum ratings

Symbol	Parameter	Value	Unit
V_{op}	Operating supply voltage	18	V
V_S	DC supply voltage	28	V
V_{peak}	Peak supply voltage (for $t = 50$ ms)	50	V
V_{CK}	CK pin voltage	6	V
V_{DATA}	Data pin voltage	6	V
I_O	Output peak current (not repetitive $t = 100$ ms)	8	A
I_O	Output peak current (repetitive $f > 10$ Hz)	6	A
P_{tot}	Power dissipation $T_{case} = 70$ °C	85	W
T_{stg}, T_j	Storage and junction temperature	-55 to 150	°C

3.2 Thermal data

Table 3. Thermal data

Symbol	Parameter	Value	Unit
$R_{th\ j-case}$	Thermal resistance junction-to-case	Max. 1	°C/W

3.3 Electrical characteristics

Refer to the test circuit, $V_S = 14.4$ V; $R_L = 4$ Ω; $f = 1$ kHz; $T_{amb} = 25$ °C; unless otherwise specified.

Table 4. Electrical characteristics

Symbol	Parameter	Test condition	Min.	Typ.	Max.	Unit
Power amplifier						
V_S	Supply voltage range	-	8	-	18	V
I_d	Total quiescent drain current	-	-	150	300	mA
P_O	Output power	EIAJ ($V_S = 13.7$ V)	32	35	-	W
		THD = 10%	22	25	-	W
		THD = 1%	-	20	-	W
		$R_L = 2$ Ω; EIAJ ($V_S = 13.7$ V)	50	55	-	W
		$R_L = 2$ Ω; THD 10%	32	38	-	W
		$R_L = 2$ Ω; THD 1%	-	30	-	W
		$R_L = 2$ Ω; Max. power	-	60	-	W

Table 4. Electrical characteristics (continued)

Symbol	Parameter	Test condition	Min.	Typ.	Max.	Unit
THD	Total harmonic distortion	$P_O = 1\text{ W to }10\text{ W}$	-	0.04	0.1	%
		$G_V = 12\text{ dB}; V_O = 0.1\text{ to }5\text{ V}_{RMS}$	-	0.02	0.05	%
C_T	Cross talk	$f = 1\text{ kHz to }10\text{ kHz}, R_g = 600\ \Omega$	50	60	-	dB
R_{IN}	Input impedance	-	80	100	130	k Ω
G_{V1}	Voltage gain 1	-	25	26	27	dB
ΔG_{V1}	Voltage gain match 1	-	-1	-	1	dB
G_{V2}	Voltage gain 2	-	11	12	13	dB
ΔG_{V2}	Voltage gain match 2	-	-1	-	1	dB
E_{IN1}	Output noise voltage 1	$R_g = 600\ \Omega, 20\text{ Hz to }22\text{ kHz}$	-	35	80	μV
E_{IN2}	Output noise voltage 2	$R_g = 600\ \Omega; G_V = 12\text{ dB}$ $20\text{ Hz to }22\text{ kHz}$	-	12	20	μV
SVR	Supply voltage rejection	$f = 100\text{ Hz to }10\text{ kHz};$ $V_r = 1\text{ V}_{pk}; R_g = 600\ \Omega$	50	60	-	dB
BW	Power bandwidth	-	100	-	-	kHz
A_{SB}	Standby attenuation	-	90	110	-	dB
I_{SB}	Standby current	-	-	25	100	μA
A_M	Mute attenuation	-	80	100	-	dB
V_{OS}	Offset voltage	Mute & play	-100	0	100	mV
V_{AM}	Min. supply mute threshold	-	7	7.5	8	V
T_{ON}	Turn-on delay	D2/D1 (IB1) 0 to 1	-	20	40	ms
T_{OFF}	Turn-off delay	D2/D1 (IB1) 1 to 0	-	20	40	ms
CD_{LK}	Clip det. high leakage current	CD off	-	0	15	μA
CD_{SAT}	Clip det. sat. voltage	CD on; $I_{CD} = 1\text{ mA}$	-	150	300	mV
CD_{THD}	Clip det. THD level	$V_S > 10\text{ V}$	-	1	2	%
Turn on diagnostics 1 (Power amplifier mode)						
Pgnd	Short to GND det. (below this limit, the Output is considered in short circuit to GND)	Power amplifier in standby condition	-	-	1.2	V
Pvs	Short to Vs det. (above this limit, the output is considered in short circuit to Vs)	-	$V_S - 1.2$	-	-	V
Pnop	Normal operation thresholds. (Within these limits, the Output is considered without faults).	-	1.8	-	$V_S - 1.8$	V
Lsc	Shorted load det.	-	-	-	0.5	Ω
Lop	Open load det.	-	130	-	-	Ω
Lnop	Normal load det.	-	1.5	-	70	Ω

Table 4. Electrical characteristics (continued)

Symbol	Parameter	Test condition	Min.	Typ.	Max.	Unit
Turn-on diagnostics 2 (Line driver mode)						
Pgnd	Short to GND det. (below this limit, the Output is considered in short circuit to GND)	Power amplifier in standby	-	-	1.2	V
Pvs	Short to Vs det. (above this limit, the output is considered in short circuit to Vs)	-	Vs -1.2	-	-	V
Pnop	Normal operation thresholds (within these limits, the output is considered without faults).	-	1.8	-	Vs -1.8	V
Lsc	Shorted load det.	-	-	-	1.5	Ω
Lop	Open load det.	-	400	-	-	Ω
Lnop	Normal load det.	-	4.5	-	200	Ω
Permanent diagnostics 2 (Power amplifier mode or line driver mode)						
Pgnd	Short to GND det. (below this limit, the Output is considered in short circuit to GND)	Power amplifier in mute or play, one or more short circuits protection activated	-	-	1.2	V
Pvs	Short to Vs det. (above this limit, the output is considered in short circuit to Vs)	-	Vs -1.2	-	-	V
Pnop	Normal operation thresholds. (within these limits, the output is considered without faults)	-	1.8	-	Vs -1.8	V
L _{SC}	Shorted load det.	Power amplifier mode	-	-	0.5	Ω
		Line driver mode	-	-	1.5	Ω
V _O	Offset detection	Power amplifier in play, AC Input signals = 0	1.5	2	2.5	V
I²C bus interface						
f _{SCL}	Clock frequency	-	-	400	-	kHz
V _{IL}	Input low voltage	-	-	-	1.5	V
V _{IH}	Input high voltage	-	2.3	-	-	V

3.4 Electrical characteristics curves

Figure 4. Quiescent current vs. supply voltage

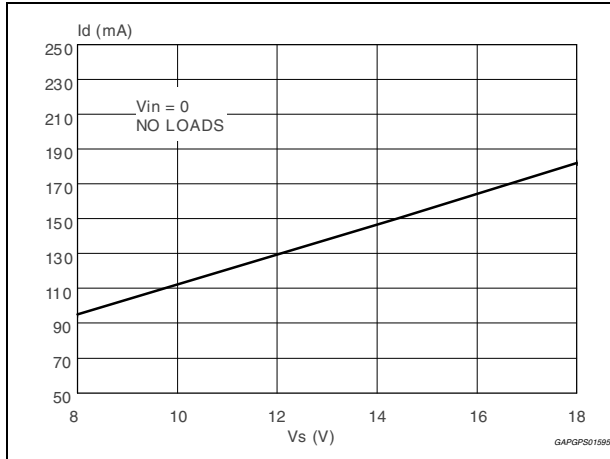

Figure 5. Output power vs. supply voltage, $R_L = 2 \Omega$

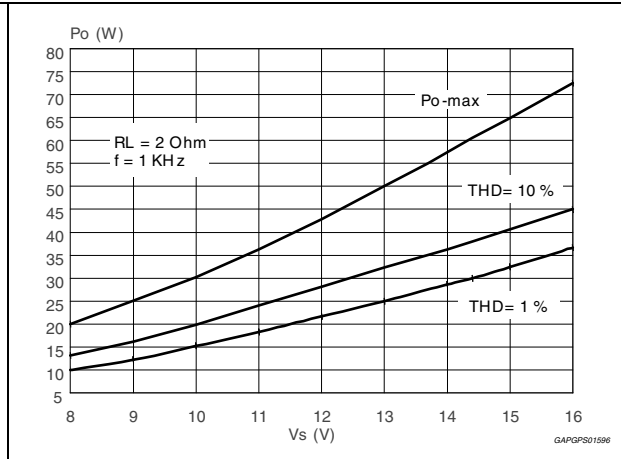

Figure 6. Output power vs. supply voltage, $R_L = 4 \Omega$

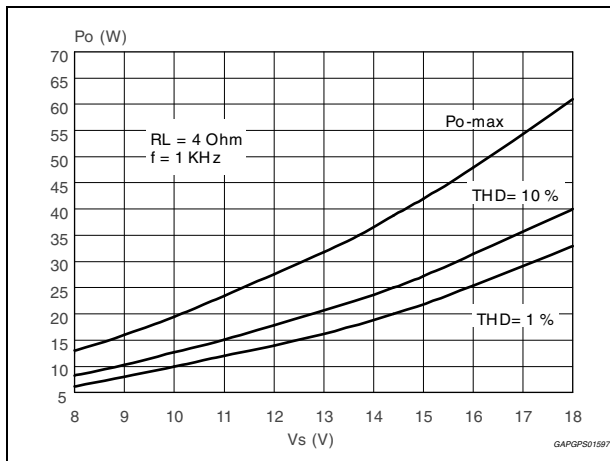

Figure 7. Distortion vs output power, $R_L = 2 \Omega$

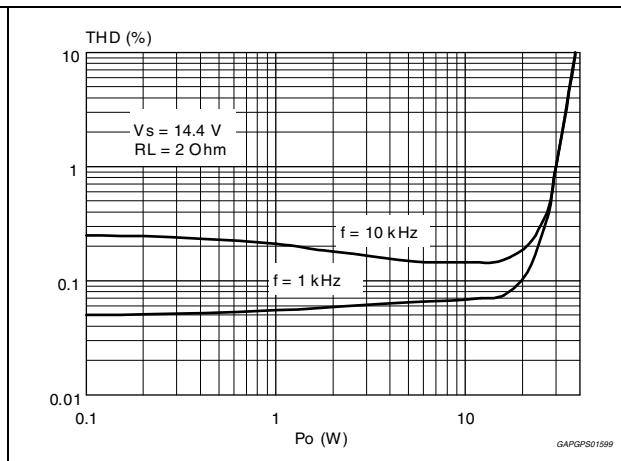

Figure 8. Distortion vs output power, $R_L = 4 \Omega$

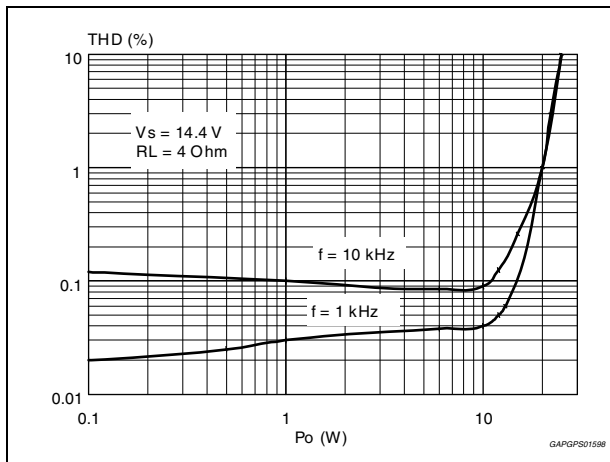

Figure 9. Distortion vs. frequency, $R_L = 2 \Omega$

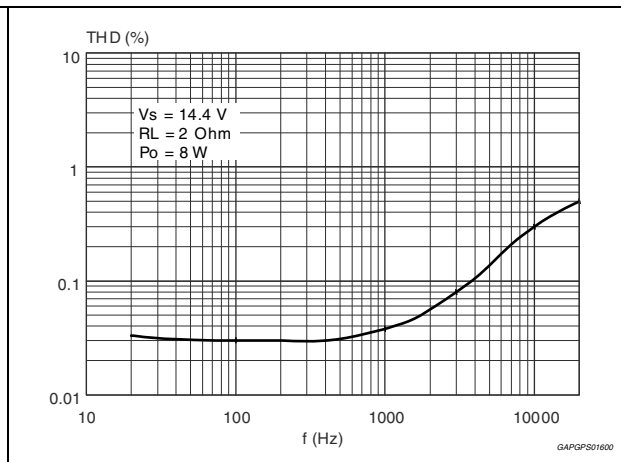

Figure 10. Distortion vs. frequency, $R_L = 4 \Omega$

Figure 11. Crosstalk vs. frequency

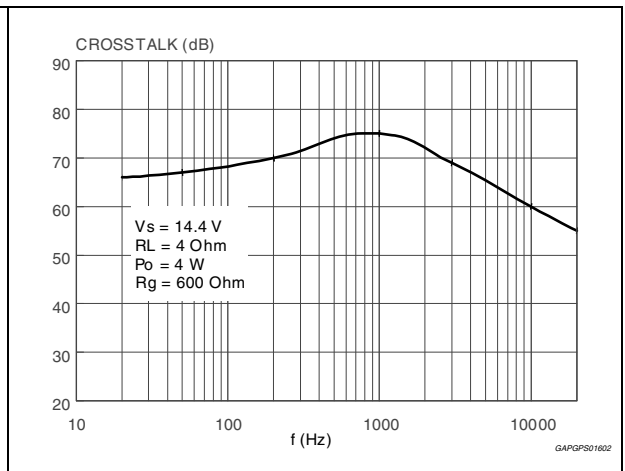
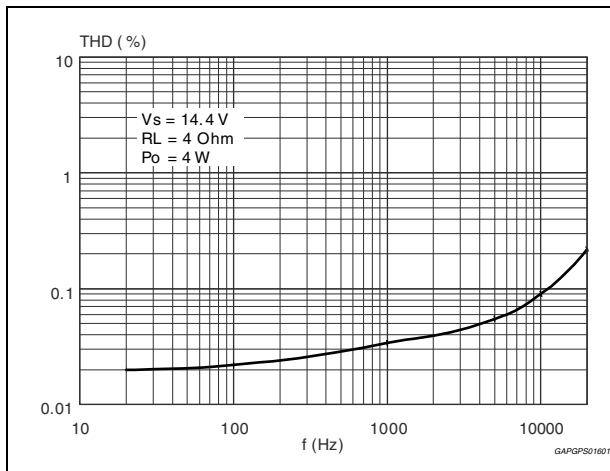

Figure 12. Supply voltage rejection vs. frequency

Figure 13. Power dissipation and efficiency vs. output power (4Ω , SINE)

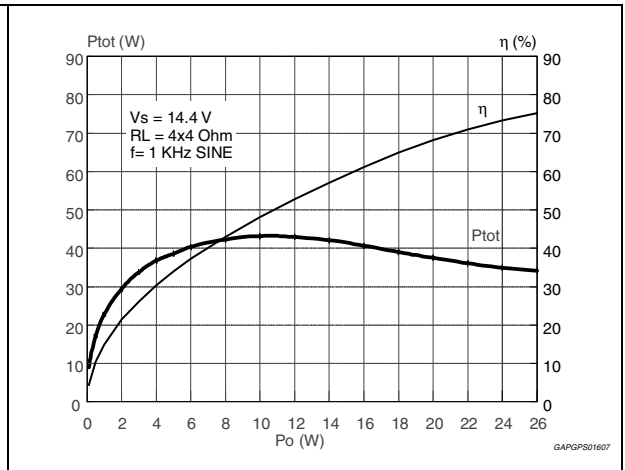
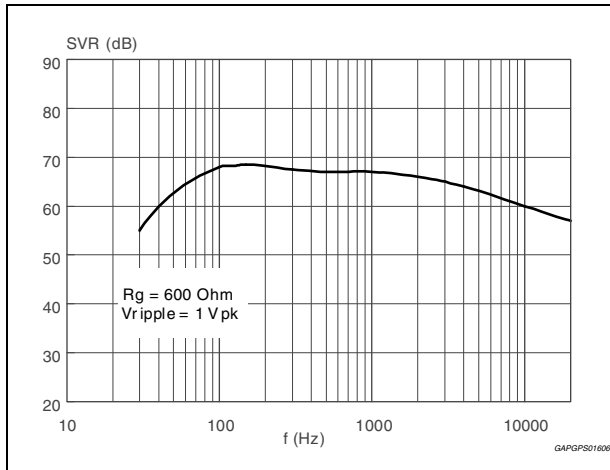
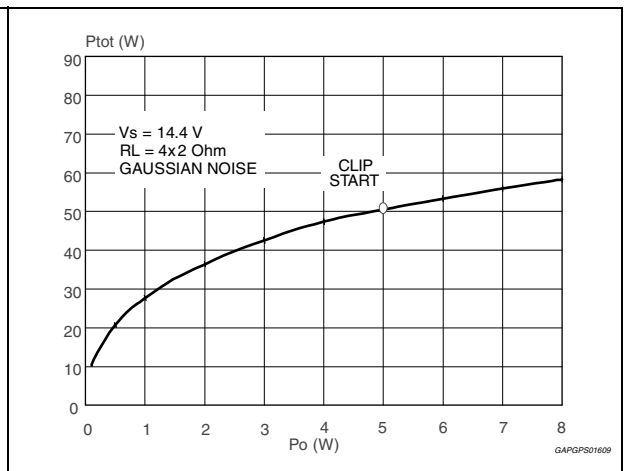
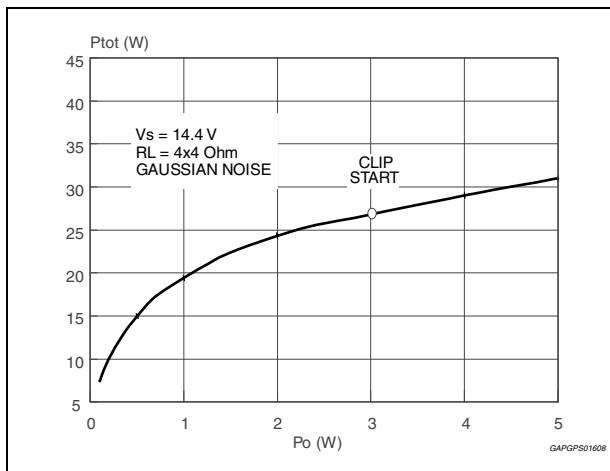

Figure 14. Power dissipation vs. average output power (audio program simulation, 4Ω)

Figure 15. Power dissipation vs. average output power (audio program simulation, 2Ω)



4 Diagnostics functional description

4.1 Turn-on diagnostic

It is activated at the turn-on (standby out) under I²C bus request. Detectable output faults are:

- Short to GND
- Short to Vs
- Short across the speaker
- Open speaker

To verify if any of the above misconnections are in place, a subsonic (inaudible) current pulse (Figure 16) is internally generated, sent through the speaker(s) and sunk back. The Turn On diagnostic status is internally stored until a successive diagnostic pulse is requested (after a I²C reading).

If the "standby out" and "diag. enable" commands are both given through a single programming step, the pulse takes place first (power stage still in stand-by mode, low, outputs = high impedance).

Afterwards, when the Amplifier is biased, the permanent diagnostic takes place. The previous Turn-on state is kept until a short appears at the outputs.

Figure 16. Turn-on diagnostic: working principle

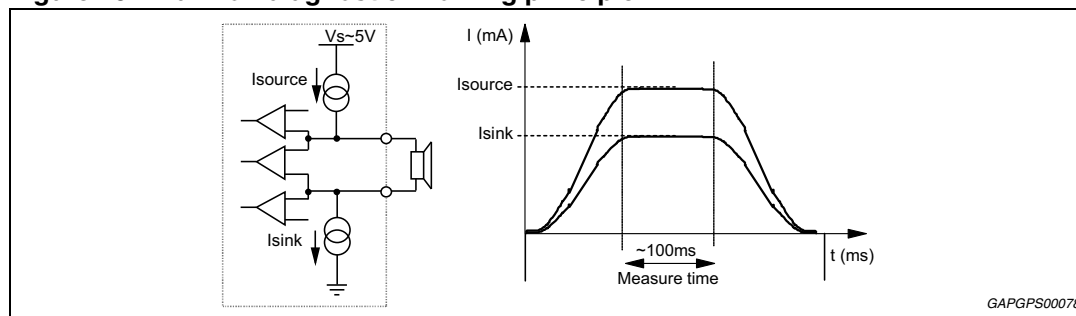

Figure 17 and 18 show SVR and output waveforms at the turn-on (stand-by out) with and without turn-on diagnostic.

Figure 17. SVR and output behaviour (case 1: without turn-on diagnostic)

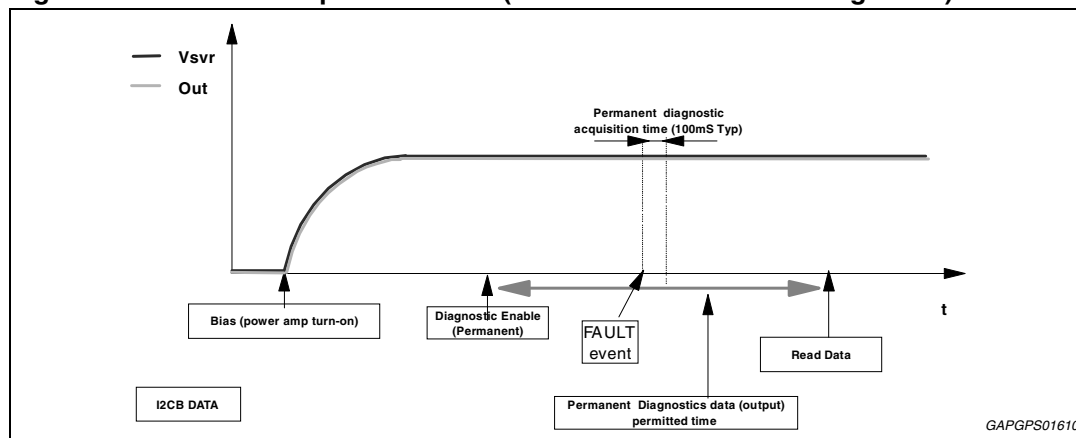
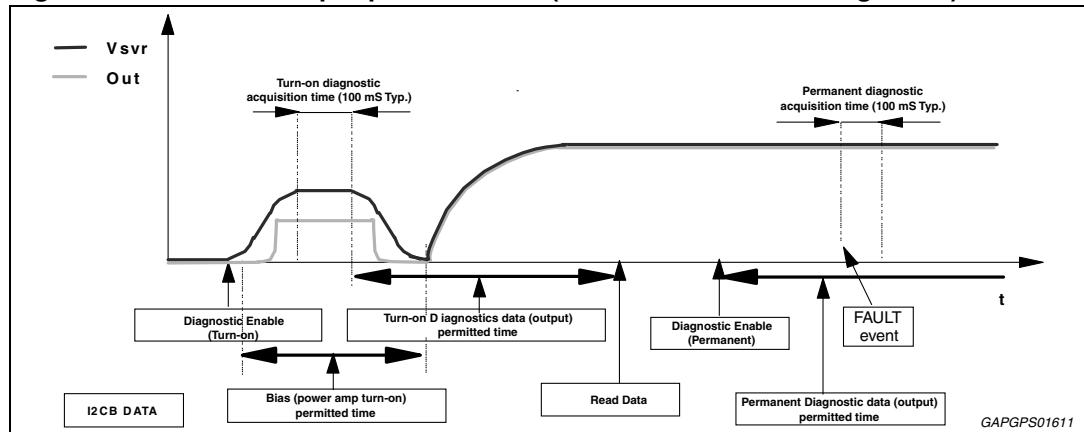
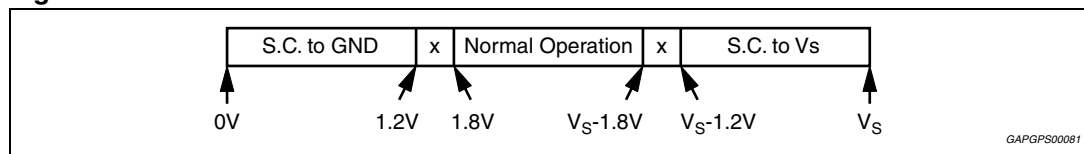

Figure 18. SVR and output pin behaviour (case 2: with turn-on diagnostic)



The information related to the outputs status is read and memorized at the end of the current pulse top. The acquisition time is 100 ms (typ.). No audible noise is generated in the process. As for short to GND / V_s the fault-detection thresholds remain unchanged from 26 dB to 12 dB gain setting. They are as follows:

Figure 19. Short circuit detection thresholds



Concerning short across the speaker / open speaker, the threshold varies from 26 dB to 12 dB gain setting, since different loads are expected (either normal speaker's impedance or high impedance). The values in case of 26 dB gain are as follows:

Figure 20. Load detection thresholds - high gain setting

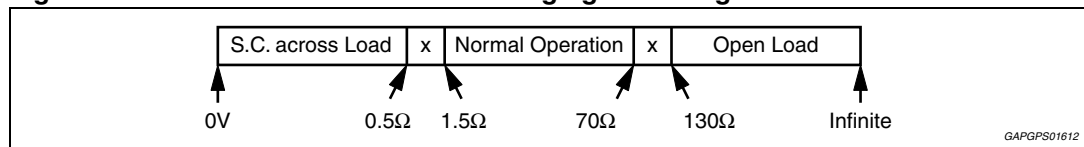

If the line-driver mode ($G_v = 12$ dB and line driver mode diagnostic = 1) is selected, the same thresholds will change as follows:

Figure 21. Load detection threshold - low gain setting

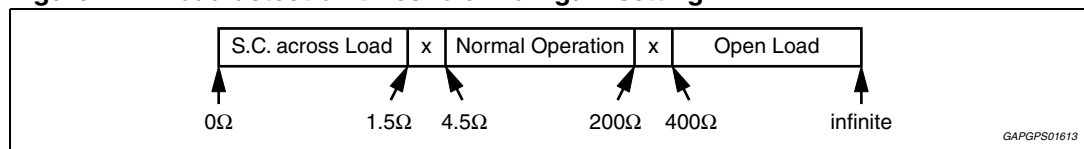

4.2 Permanent diagnostics

Detectable conventional faults are:

- Short to GND
- Short to Vs
- Short across the speaker

The following additional features are provided:

- Output offset detection

The TDA7561 has 2 operating statuses:

1. Restart mode. The diagnostic is not enabled. Each audio channel operates independently from each other. If any of the a.m. faults occurs, only the channel(s) interested is shut down. A check of the output status is made every 1 ms (*Figure 22*). Restart takes place when the overload is removed.
2. Diagnostic mode. It is enabled via I²C bus and self activates if an output overload (such to cause the intervention of the short-circuit protection) occurs to the speakers outputs. Once activated, the diagnostics procedure develops as follows (*Figure 23*):
 - To avoid momentary re-circulation spikes from giving erroneous diagnostics, a check of the output status is made after 1ms: if normal situation (no overloads) is detected, the diagnostic is not performed and the channel returns back active.
 - Instead, if an overload is detected during the check after 1 ms, then a diagnostic cycle having a duration of about 100 ms is started.
 - After a diagnostic cycle, the audio channel interested by the fault is switched to restart mode. The relevant data are stored inside the device and can be read by the microprocessor. When one cycle has terminated, the next one is activated by an I²C reading. This is to ensure continuous diagnostics throughout the car-radio operating time.
 - To check the status of the device a sampling system is needed. The timing is chosen at microprocessor level (over half a second is recommended).

Figure 22. Restart timing without diagnostic enable (permanent) - Each 1 mS time, a sampling of the fault is done

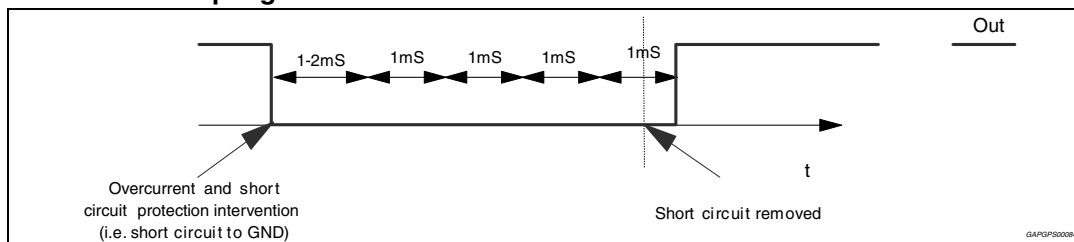
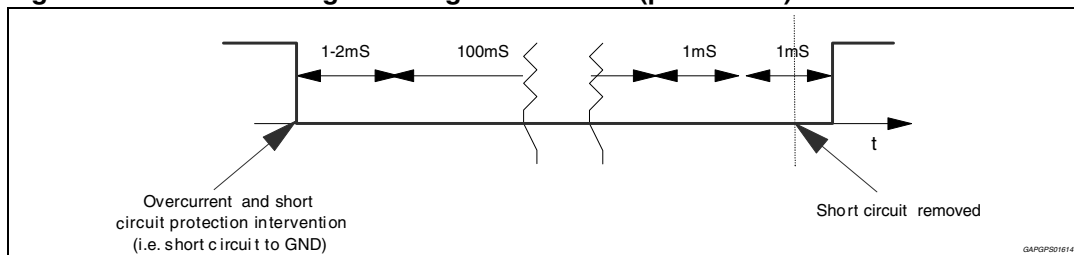

Figure 23. Restart timing with diagnostic enable (permanent)



4.3 Output DC offset detection

Any DC output offset exceeding ± 2 V are signalled out. This inconvenient might occur as a consequence of initially defective or aged and worn-out input capacitors feeding a DC component to the inputs, so putting the speakers at risk of overheating.

This diagnostic has to be performed with low-level output AC signal (or $V_{in} = 0$).

The test is run with selectable time duration by microprocessor (from a "start" to a "stop" command):

- Start = Last reading operation or setting IB1 - D5 - (offset enable) to 1
- Stop = Actual reading operation

Excess offset is signalled out if persistent throughout the assigned testing time. This feature is disabled if any overloads leading to activation of the short-circuit protection occurs in the process.

5 Multiple faults

When more misconnections are simultaneously in place at the audio outputs, it is guaranteed that at least one of them is initially read out. The others are notified after successive cycles of I²C reading and faults removal, provided that the diagnostic is enabled. This is true for both kinds of diagnostic (turn on and permanent).

The table below shows all the couples of possible double-fault. It should be taken into account that a short circuit with the 4 ohm speaker unconnected is considered as double fault.

Table 5. Double fault table for turn-on diagnostic

	S. GND (so)	S. GND (sk)	S. Vs	S. Across L.	Open L.
S. GND (so)	S. GND	S. GND	S. Vs + S. GND	S. GND	S. GND
S. GND (sk)	/	S. GND	S. Vs	S. GND	Open L. (*)
S. Vs	/	/	S. Vs	S. Vs	S. Vs
S. Across L.	/	/	/	S. Across L.	N.A.
Open L.	/	/	/	/	Open L. (*)

S. GND (so) / S. GND (sk) in the above table make a distinction according to which of the 2 outputs is shorted to ground (test-current source side= so, test-current sink side = sk). More precisely, so = CH+, sk = CH-.

In permanent diagnostic the table is the same, with only a difference concerning Open Load(*), which is not among the recognizable faults. Should an Open Load be present during the device's normal working, it would be detected at a subsequent Turn on Diagnostic cycle (i.e. at the successive Car Radio Turn on).

5.1 Faults availability

All the results coming from I²C bus, by read operations, are the consequence of measurements inside a defined period of time. If the fault is stable throughout the whole period, it will be sent out.

To guarantee always resident functions, every kind of diagnostic cycles (Turn-on, Permanent, Offset) will be reactivate after any I²C reading operation. So, when the microprocessor reads the I²C, a new cycle will be able to start, but the read data will come from the previous diag. cycle (i.e. The device is in turn-on state, with a short to GND, then the short is removed and micro reads I²C. The short to GND is still present in bytes, because it is the result of the previous cycle. If another I²C reading operation occurs, the bytes do not show the short). In general to observe a change in diagnostic bytes, two I²C reading operations are necessary.

6 I²C bus

6.1 I²C programming/reading sequence

A correct turn on/off sequence respectful of the diagnostic timings and producing no audible noises could be as follows (after battery connection):

- Turn-on: (Standby out + Diag enable) --- 500 ms (min) --- Muting out
- Turn-off: Muting in --- 20 ms --- (Diag disable + Standby in)
- Car radio installation: Diag enable (write) --- 200 ms --- I²C read (repeat until All faults disappear).
- Offset test: Device in Play (no signal) -- Offset enable - 30 ms - I²C reading (repeat I²C reading until high-offset message disappears).

6.2 I²C bus interface

Data transmission from microprocessor to the TDA7561 and viceversa takes place through the 2 wires I²C bus interface, consisting of the two lines SDA and SCL (pull-up resistors to positive supply voltage must be connected).

6.2.1 Data validity

As shown by [Figure 24](#), the data on the SDA line must be stable during the high period of the clock.

The High and Low state of the data line can only change when the clock signal on the SCL line is Low.

6.2.2 Start and stop conditions

As shown by [Figure 25](#) a start condition is a High to Low transition of the SDA line while SCL is HIGH.

The stop condition is a Low to High transition of the SDA line while SCL is High.

6.2.3 Byte format

Every byte transferred to the SDA line must contain 8 bits. Each byte must be followed by an acknowledge bit. The MSB is transferred first.

6.2.4 Acknowledge

The transmitter puts a resistive HIGH level on the SDA line during the acknowledge clock pulse (see [Figure 26](#)). The receiver acknowledges by pulling the SDA line LOW during the acknowledge clock pulse, so that the SDA line is stable LOW during this clock pulse.

Transmitter:

- master (μ P) when it writes an address to the TDA7561
- slave (TDA7561) when the μ P reads a data byte from TDA7561

Receiver:

- slave (TDA7561) when the μ P writes an address to the TDA7561
- master (μ P) when it reads a data byte from TDA7561

Figure 24. Data validity on the I²C bus

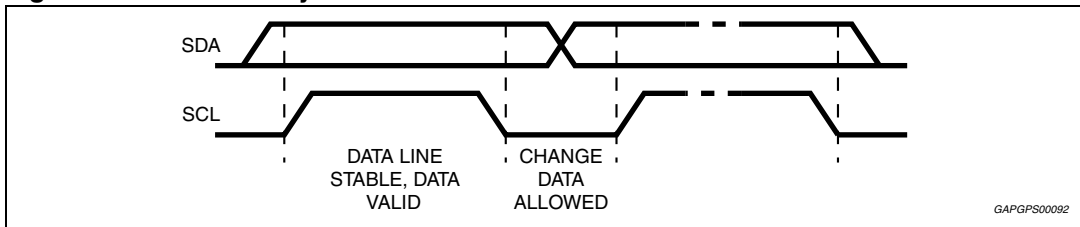

Figure 25. Timing diagram on the I²C bus

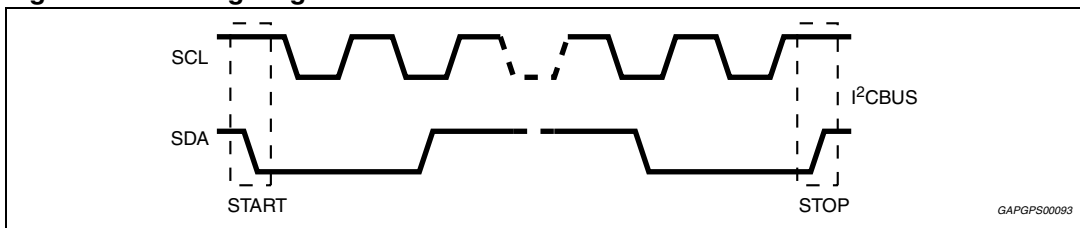
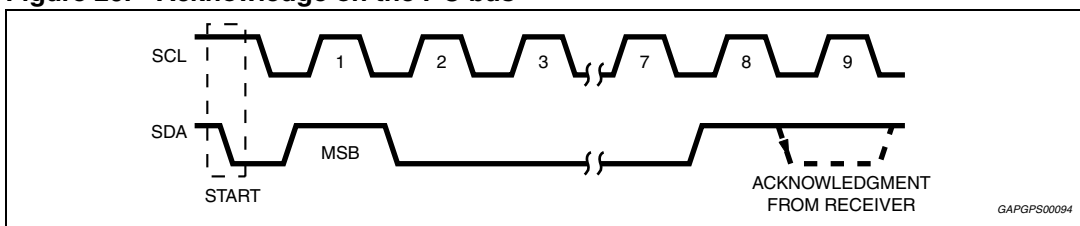

Figure 26. Acknowledge on the I²C bus



7 Software specifications

All the functions of the TDA7561 are activated by I²C interface.

The bit 0 of the "Address byte" defines if the next bytes are write instruction (from μ P to TDA7561) or read instruction (from TDA7561 to μ P).

Chip address

D7								D0	
1	1	0	1	1	0	0	0	X	D8 Hex

X = 0 Write to device

X = 1 Read from device

If R/W = 0, the μ P sends 2 "Instruction Bytes": IB1 and IB2.

Table 6. IB1

Bit	Instruction decoding bit
D7	X
D6	Diagnostic enable (D6 = 1) Diagnostic defeat (D6 = 0)
D5	Offset detection enable (D5 = 1) Offset detection defeat (D5 = 0)
D4	Front channel Gain = 26dB (D4 = 0) Gain = 12dB (D4 = 1)
D3	Rear channel Gain = 26dB (D3 = 0) Gain = 12dB (D3 = 1)
D2	Mute front channels (D2 = 0) Unmute front channels (D2 = 1)
D1	Mute rear channels (D1 = 0) Unmute rear channels (D1 = 1)
D0	X

Table 7. IB2

Bit	Instruction decoding bit
D7	X
D6	Used for testing
D5	Used for testing
D4	Standby on - Amplifier not working - (D4 = 0) Standby off - Amplifier working - (D4 = 1)
D3	Power amplifier mode diagnostic (D3 = 0) Line driver mode diagnostic (D3 = 1)
D2	X
D1	X
D0	X

If R/W = 1, the TDA7561 sends 4 "Diagnostics Bytes" to μ P: DB1, DB2, DB3 and DB4.

Table 8. DB1

Bit	Instruction decoding bit
D7	Thermal warning active (D7 = 1)
D6	Diag. cycle not activated or not terminated (D6 = 0) Diag. cycle terminated (D6 = 1)
D5	X
D4	Channel LFTurn-on diagnostic (D4 = 0) Permanent diagnostic (D4 = 1)
D3	Channel LF Normal load (D3 = 0) Short load (D3 = 1)
D2	Channel LFTurn-on diag.: No open load (D2 = 0) Open load detection (D2 = 1) Offset diag.: No output offset (D2 = 0) Output offset detection (D2 = 1)
D1	Channel LFNo short to Vcc (D1 = 0)Short to Vcc (D1 = 1)
D0	Channel LFNo short to GND (D1 = 0)Short to GND (D1 = 1)

Table 9. DB2

Bit	Instruction decoding bit
D7	Offset detection not activated (D7 = 0) Offset detection activated (D7 = 1)
D6	X
D5	X
D4	Channel LR Turn-on diagnostic (D4 = 0) Permanent diagnostic (D4 = 1)
D3	Channel LR Normal load (D3 = 0) Short load (D3 = 1)
D2	Channel LR Turn-on diag.: No open load (D2 = 0) Open load detection (D2 = 1) Permanent diag.: No output offset (D2 = 0) Output offset detection (D2 = 1)
D1	Channel LR No short to Vcc (D1 = 0) Short to Vcc (D1 = 1)
D0	Channel LR No short to GND (D1 = 0) Short to GND (D1 = 1)

Table 10. DB3

Bit	Instruction decoding bit
D7	Standby status (= IB1 - D4)
D6	Diagnostic status (= IB1 - D6)
D5	X
D4	Channel RF Turn-on diagnostic (D4 = 0) Permanent diagnostic (D4 = 1)
D3	Channel RF Normal load (D3 = 0) Short load (D3 = 1)
D2	Channel RF Turn-on diag.: No open load (D2 = 0) Open load detection (D2 = 1) Permanent diag.: No output offset (D2 = 0) Output offset detection (D2 = 1)
D1	Channel RF No short to Vcc (D1 = 0) Short to Vcc (D1 = 1)
D0	Channel RF No short to GND (D1 = 0) Short to GND (D1 = 1)

Table 11. DB4

Bit	Instruction decoding bit
D7	X
D6	X
D5	X
D4	Channel RR Turn-on diagnostic (D4 = 0) Permanent diagnostic (D4 = 1)
D3	Channel RR Normal load (D3 = 0) Short load (D3 = 1)
D2	Channel RR Turn-on diag.: No open load (D2 = 0) Open load detection (D2 = 1) Permanent diag.: No output offset (D2 = 0) Output offset detection (D2 = 1)
D1	Channel RR No short to Vcc (D1 = 0) Short to Vcc (D1 = 1)
D0	Channel RR No short to GND (D1 = 0) Short to GND (D1 = 1)

8 Examples of bytes sequence

1 - Turn-on diagnostic - Write operation

Start	Address byte with D0 = 0	ACK	IB1 with D6 = 1	ACK	IB2	ACK	STOP
-------	--------------------------	-----	-----------------	-----	-----	-----	------

2 - Turn-on diagnostic - Read operation

Start	Address byte with D0 = 1	ACK	DB1	ACK	DB2	ACK	DB3	ACK	DB4	ACK	STOP
-------	--------------------------	-----	-----	-----	-----	-----	-----	-----	-----	-----	------

The delay from 1 to 2 can be selected by software, starting from 1 ms

3a - Turn-on of the power amplifier with 26 dB gain, mute on, diagnostic defeat.

Start	Address byte with D0 = 0	ACK	IB1	ACK	IB2	ACK	STOP
			X000000X		XXX1X0XX		

3b - Turn-off of the power amplifier

Start	Address byte with D0 = 0	ACK	IB1	ACK	IB2	ACK	STOP
			X0XXXXXX		XXX0XXXX		

4 - Offset detection procedure enable

Start	Address byte with D0 = 0	ACK	IB1	ACK	IB2	ACK	STOP
			XX1XX11X		XXX1X0XX		

5 - Offset detection procedure stop and reading operation (the results are valid only for the offset detection bits (D2 of the bytes DB1, DB2, DB3, DB4).

Start	Address byte with D0 = 1	ACK	DB1	ACK	DB2	ACK	DB3	ACK	DB4	ACK	STOP
-------	--------------------------	-----	-----	-----	-----	-----	-----	-----	-----	-----	------

- The purpose of this test is to check if a DC offset (2V typ.) is present on the outputs, produced by input capacitor with anomalous leakage current or humidity between pins.
- The delay from 4 to 5 can be selected by software, starting from 1 ms.

9 Package information

In order to meet environmental requirements, ST offers these devices in different grades of ECOPACK® packages, depending on their level of environmental compliance. ECOPACK® specifications, grade definitions and product status are available at: www.st.com.

ECOPACK® is an ST trademark.

Figure 27. Flexiwatt25 (vertical) mechanical data and package dimensions

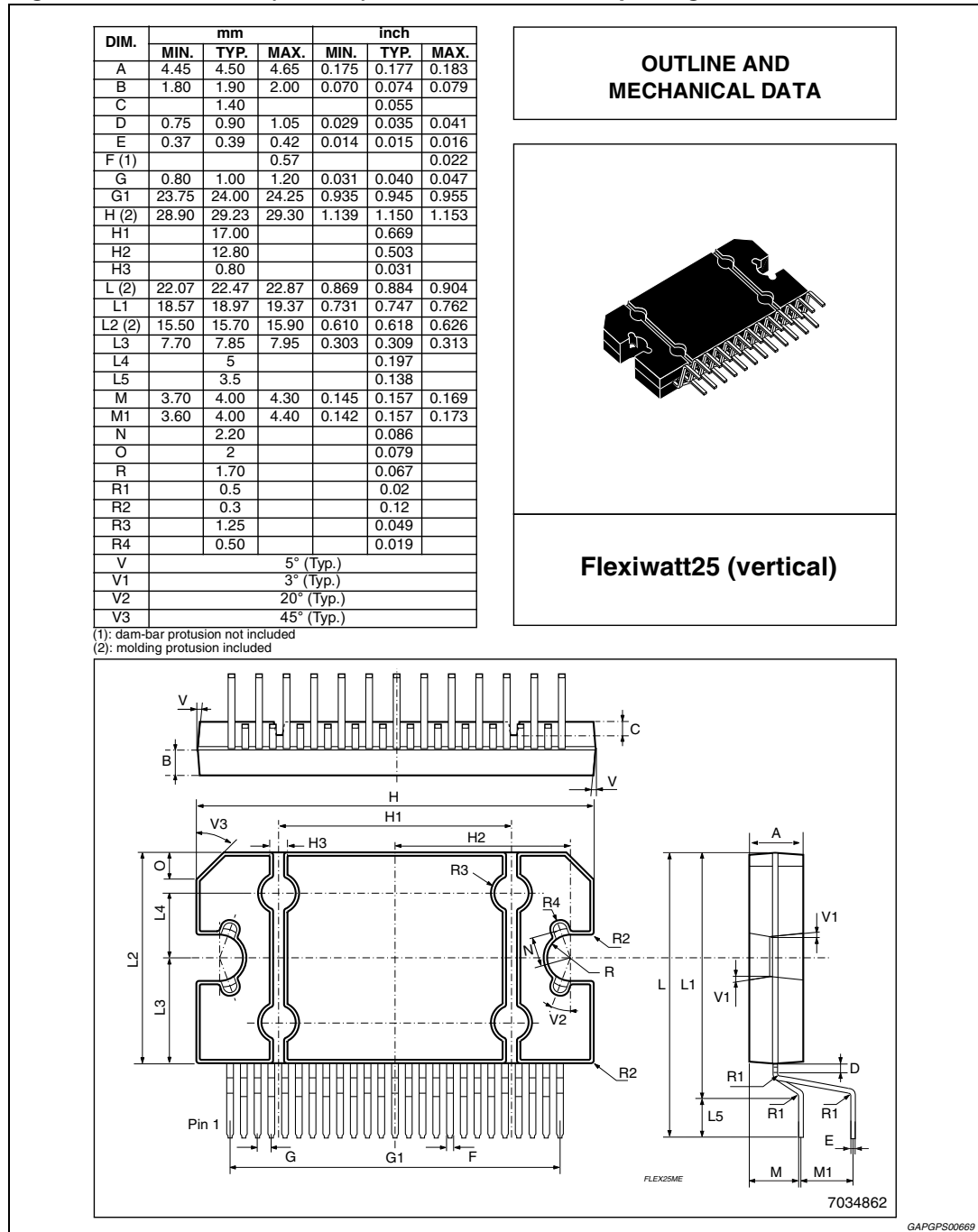
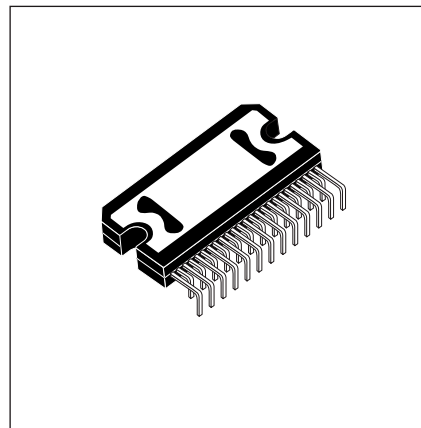

Figure 28. Flexiwatt25 (horizontal) mechanical data and package dimensions

DIM.	mm			inch		
	MIN.	TYP.	MAX.	MIN.	TYP.	MAX.
A	4.45	4.50	4.65	0.175	0.177	0.183
B	1.80	1.90	2.00	0.070	0.074	0.079
C		1.40			0.055	
D		2.00			0.079	
E	0.37	0.39	0.42	0.014	0.015	0.016
F ⁽¹⁾			0.57			0.022
G	0.75	1.00	1.25	0.029	0.040	0.049
G1	23.70	24.00	24.30	0.933	0.945	0.957
H ⁽²⁾	28.90	29.23	29.30	1.139	1.150	1.153
H1		17.00			0.669	
H2		12.80			0.503	
H3		0.80			0.031	
L ⁽²⁾	21.64	22.04	22.44	0.852	0.868	0.883
L1	10.15	10.5	10.85	0.40	0.413	0.427
L2 ⁽²⁾	15.50	15.70	15.90	0.610	0.618	0.626
L3	7.70	7.85	7.95	0.303	0.309	0.313
L4		5			0.197	
L5	5.15	5.45	5.85	0.203	0.214	0.23
L6	1.80	1.95	2.10	0.070	0.077	0.083
M	2.75	3.00	3.50	0.108	0.118	0.138
M1		4.73			0.186	
M2		5.61			0.220	
N		2.20			0.086	
P	3.20	3.50	3.80	0.126	0.138	0.15
R		1.70			0.067	
R1		0.50			0.02	
R2		0.30			0.12	
R3		1.25			0.049	
R4		0.50			0.02	
V				5° (Typ.)		
V1				3° (Typ.)		
V2				20° (Typ.)		
V3				45° (Typ.)		

OUTLINE AND MECHANICAL DATA



Flexiwatt25 (Horizontal)

(1): Dam-bar protusion not included; (2): Molding protusion included.

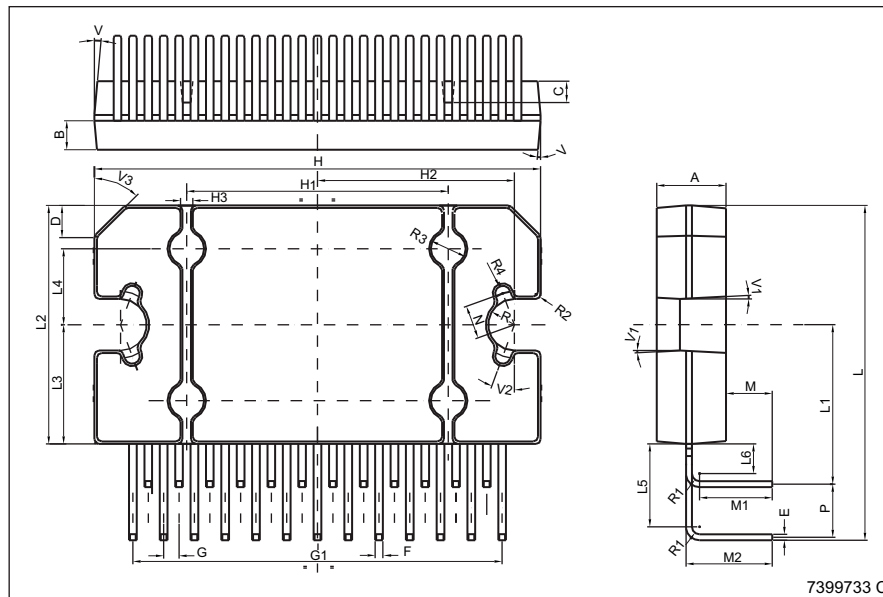

7399733 C

GAPGPS01239

10 Revision history

Table 12. Document revision history

Date	Revision	Changes
December 2002	4	-
17-May-2012	5	Document reformatted. Added Table 1: Device summary on page 1 . Added Figure 28: Flexivatt25 (horizontal) mechanical data and package dimensions on page 25 .
16-Sep-2103	6	Updated Disclaimer.

Please Read Carefully:

Information in this document is provided solely in connection with ST products. STMicroelectronics NV and its subsidiaries ("ST") reserve the right to make changes, corrections, modifications or improvements, to this document, and the products and services described herein at any time, without notice.

All ST products are sold pursuant to ST's terms and conditions of sale.

Purchasers are solely responsible for the choice, selection and use of the ST products and services described herein, and ST assumes no liability whatsoever relating to the choice, selection or use of the ST products and services described herein.

No license, express or implied, by estoppel or otherwise, to any intellectual property rights is granted under this document. If any part of this document refers to any third party products or services it shall not be deemed a license grant by ST for the use of such third party products or services, or any intellectual property contained therein or considered as a warranty covering the use in any manner whatsoever of such third party products or services or any intellectual property contained therein.

UNLESS OTHERWISE SET FORTH IN ST'S TERMS AND CONDITIONS OF SALE ST DISCLAIMS ANY EXPRESS OR IMPLIED WARRANTY WITH RESPECT TO THE USE AND/OR SALE OF ST PRODUCTS INCLUDING WITHOUT LIMITATION IMPLIED WARRANTIES OF MERCHANTABILITY, FITNESS FOR A PARTICULAR PURPOSE (AND THEIR EQUIVALENTS UNDER THE LAWS OF ANY JURISDICTION), OR INFRINGEMENT OF ANY PATENT, COPYRIGHT OR OTHER INTELLECTUAL PROPERTY RIGHT.

ST PRODUCTS ARE NOT DESIGNED OR AUTHORIZED FOR USE IN: (A) SAFETY CRITICAL APPLICATIONS SUCH AS LIFE SUPPORTING, ACTIVE IMPLANTED DEVICES OR SYSTEMS WITH PRODUCT FUNCTIONAL SAFETY REQUIREMENTS; (B) AERONAUTIC APPLICATIONS; (C) AUTOMOTIVE APPLICATIONS OR ENVIRONMENTS, AND/OR (D) AEROSPACE APPLICATIONS OR ENVIRONMENTS. WHERE ST PRODUCTS ARE NOT DESIGNED FOR SUCH USE, THE PURCHASER SHALL USE PRODUCTS AT PURCHASER'S SOLE RISK, EVEN IF ST HAS BEEN INFORMED IN WRITING OF SUCH USAGE, UNLESS A PRODUCT IS EXPRESSLY DESIGNATED BY ST AS BEING INTENDED FOR "AUTOMOTIVE, AUTOMOTIVE SAFETY OR MEDICAL" INDUSTRY DOMAINS ACCORDING TO ST PRODUCT DESIGN SPECIFICATIONS. PRODUCTS FORMALLY ESCC, QML OR JAN QUALIFIED ARE DEEMED SUITABLE FOR USE IN AEROSPACE BY THE CORRESPONDING GOVERNMENTAL AGENCY.

Resale of ST products with provisions different from the statements and/or technical features set forth in this document shall immediately void any warranty granted by ST for the ST product or service described herein and shall not create or extend in any manner whatsoever, any liability of ST.

ST and the ST logo are trademarks or registered trademarks of ST in various countries.

Information in this document supersedes and replaces all information previously supplied.

The ST logo is a registered trademark of STMicroelectronics. All other names are the property of their respective owners.

© 2013 STMicroelectronics - All rights reserved

STMicroelectronics group of companies

Australia - Belgium - Brazil - Canada - China - Czech Republic - Finland - France - Germany - Hong Kong - India - Israel - Italy - Japan - Malaysia - Malta - Morocco - Philippines - Singapore - Spain - Sweden - Switzerland - United Kingdom - United States of America

www.st.com