

SN54LS640 THRU SN54LS642, SN54LS644, SN54LS645 SN74LS640 THRU SN74LS642, SN74LS644, SN74LS645 OCTAL BUS TRANSCEIVERS

SDLS189 – APRIL 1979 – REVISED MARCH 1988

- SN74LS64X-1 Versions Rated at I_{OL} of 48 mA
- Bi-directional Bus Transceivers in High-Density 20-Pin Packages
- Hysteresis at Bus Inputs Improves Noise Margins
- Choice of True or Inverting Logic
- Choice of 3-State or Open-Collector Outputs

DEVICE	OUTPUT	LOGIC
'LS640	3-State	Inverting
'LS641	Open-Collector	True
'LS642	Open-Collector	Inverting
'LS644	Open-Collector	True and inverting
'LS645	3-State	True

description

These octal bus transceivers are designed for asynchronous two-way communication between data buses. The devices transmit data from the A bus to the B bus or from the B bus to the A bus depending upon the level at the direction control (DIR) input. The enable input (\bar{G}) can be used to disable the device so the buses are effectively isolated.

The -1 versions of the SN74LS640 thru SN74LS642, SN74LS644, and SN74LS645 are identical to the standard versions except that the recommended maximum I_{OL} is increased to 48 milliamperes. There are no -1 versions of the SN54LS640 thru SN54LS642, SN54LS644, and SN54LS645.

The SN54LS640 thru SN54LS642, SN54LS644, and SN54LS645 are characterized for operation over the full military temperature range of -55°C to 125°C . The SN74LS640 thru SN74LS642, SN74LS644, and SN74LS645 are characterized for operation from 0°C to 70°C .

SN54LS' . . . J PACKAGE
SN74LS' . . . DW OR N PACKAGE
(TOP VIEW)

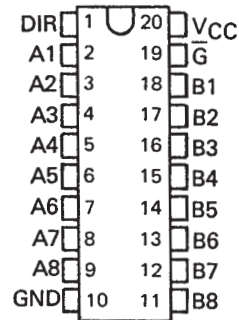

SN54LS' . . . FK PACKAGE
(TOP VIEW)

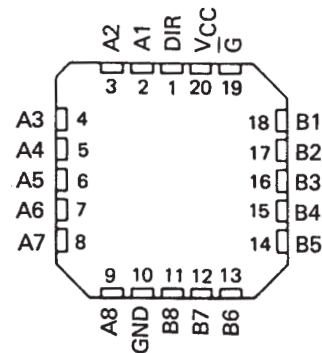

FUNCTION TABLE

CONTROL INPUTS		OPERATION		
\bar{G}	DIR	'LS640 'LS642	'LS641 'LS645	'LS644
L	L	B data to A bus	B data to A bus	B data to A bus
L	H	A data to B bus	A data to B bus	\bar{A} data to B bus
H	X	Isolation	Isolation	Isolation

H = high level, L = low level, X = irrelevant

SN54LS640 THRU SN54LS642, SN54LS644, SN54LS645 SN74LS640 THRU SN74LS642, SN74LS644, SN74LS645 OCTAL BUS TRANSCEIVERS

SDLS189 – APRIL 1979 – REVISED MARCH 1988

logic symbols†

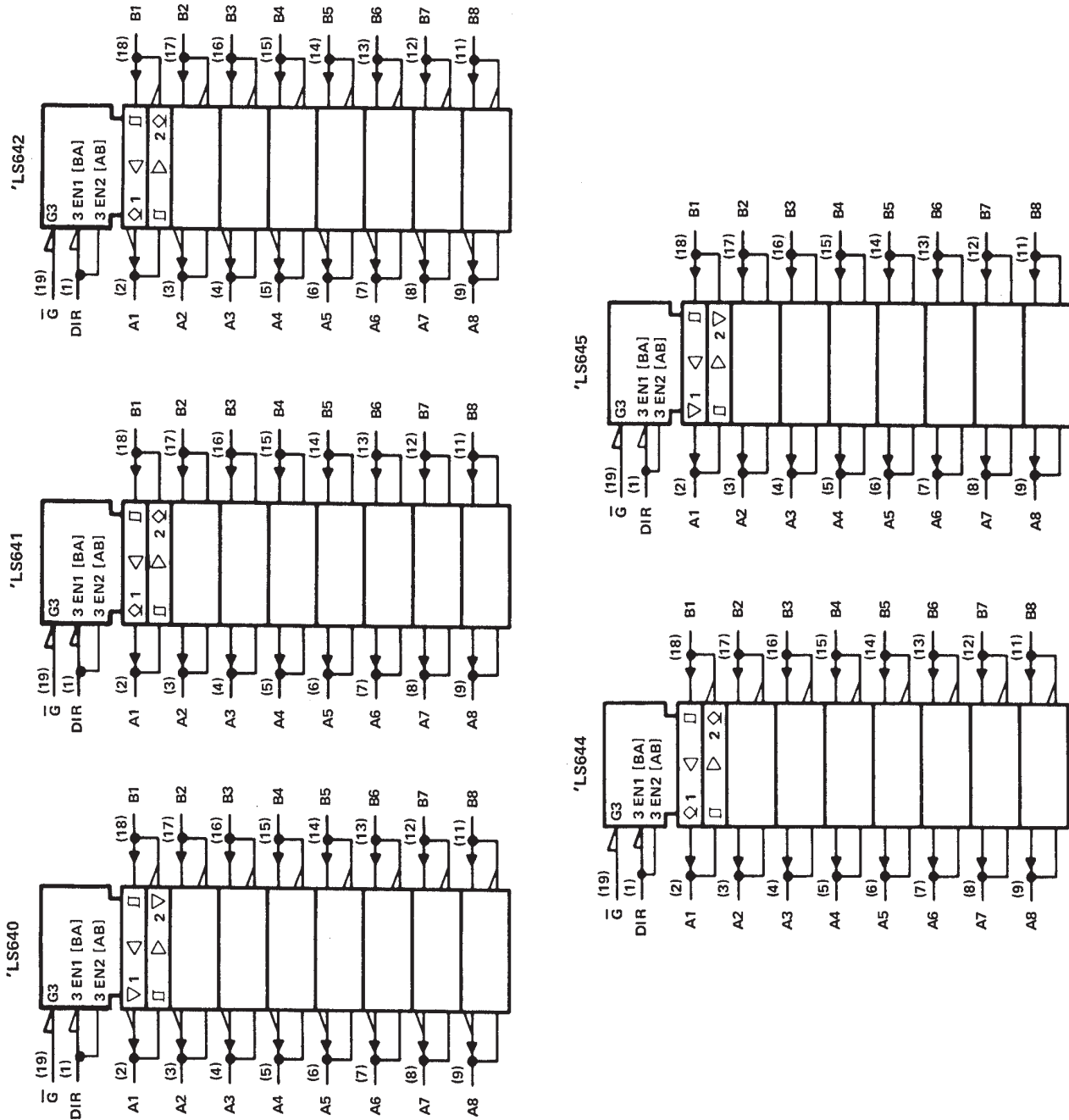

† These symbols are in accordance with ANSI/IEEE Std 91-1984 and IEC Publication 617-12.
Pin numbers shown are for DW, J, and N packages.

SN54LS640, SN54LS645
SN74LS640, SN74LS645
OCTAL BUS TRANSCEIVERS WITH 3-STATE OUTPUTS

SDLS189 – APRIL 1979 – REVISED MARCH 1988

switching characteristics, $V_{CC} = 5\text{ V}$, $T_A = 25^\circ\text{C}$

PARAMETER	FROM (INPUT)	TO (OUTPUT)	TEST CONDITIONS	'LS640, 'LS640-1			'LS645, 'LS645-1			UNIT
				MIN	TYP	MAX	MIN	TYP	MAX	
t_{PLH} Propagation delay time, low-to-high-level output	A	B	$C_L = 45\text{ pF}$, $R_L = 667\ \Omega$, See Note 2		6	10		8	15	ns
	B	A			6	10		8	15	
t_{PHL} Propagation delay time, high-to-low-level output	A	B			8	15		11	15	ns
	B	A			8	15		11	15	
t_{PZL} Output enable time to low level	\overline{G}	A			31	40		31	40	ns
	\overline{G}	B			31	40		31	40	
t_{PZH} Output enable time to high level	\overline{G}	A			23	40		26	40	ns
	\overline{G}	B			23	40		26	40	
t_{PLZ} Output disable time from low level	\overline{G}	A	$C_L = 5\text{ pF}$, $R_L = 667\ \Omega$, See Note 2		15	25		15	25	ns
	\overline{G}	B			15	25		15	25	
t_{PHZ} Output disable time from high level	\overline{G}	A			15	25		15	25	ns
	\overline{G}	B			15	25		15	25	

NOTE 2: Load circuits and voltage waveforms are shown in Section 1.

schematics of inputs and outputs

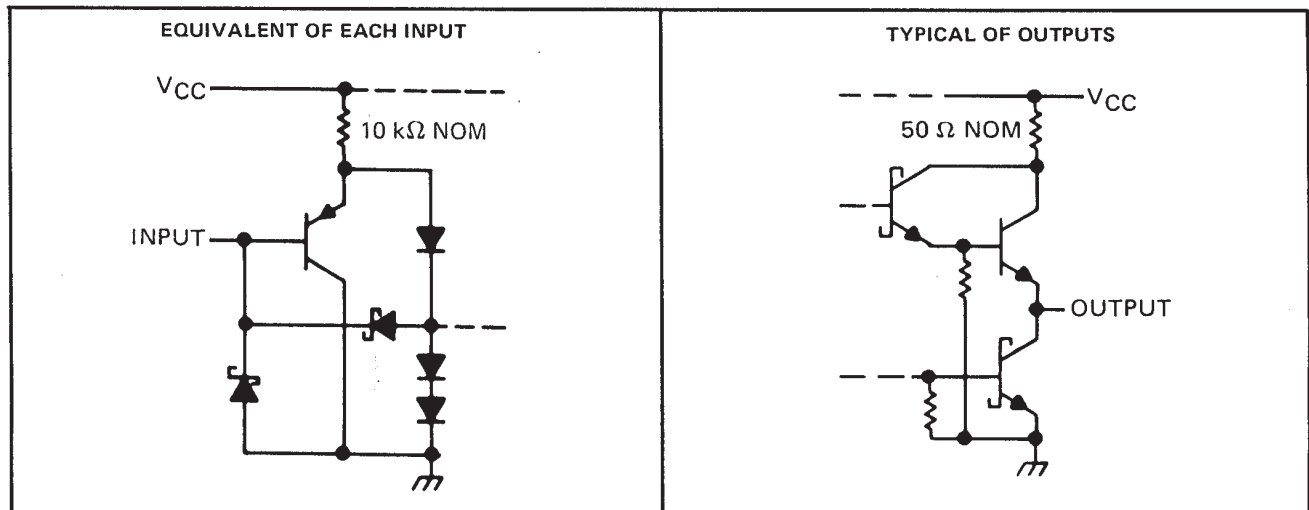

TYPICAL CHARACTERISTICS

SN54LS'
 INVERTING OUTPUT VOLTAGE
 vs
 INPUT VOLTAGE

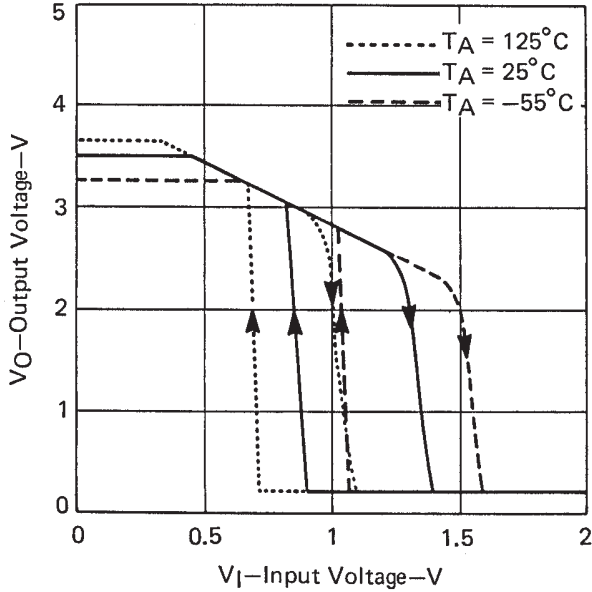

FIGURE 1

SN74LS'
 INVERTING OUTPUT VOLTAGE
 vs
 INPUT VOLTAGE

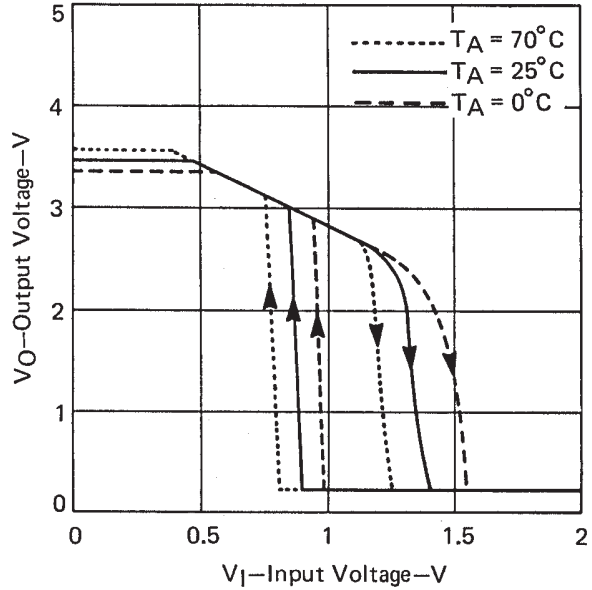

FIGURE 2

SN54LS'
 NONINVERTING OUTPUT VOLTAGE
 vs
 INPUT VOLTAGE

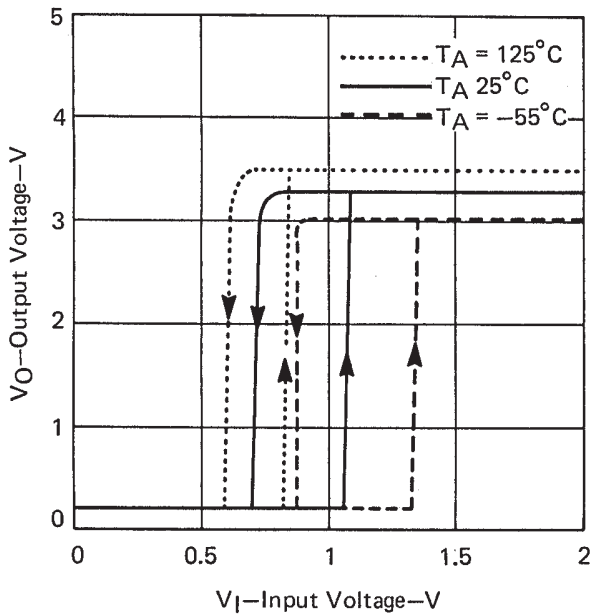

FIGURE 3

SN74LS'
 NONINVERTING OUTPUT VOLTAGE
 vs
 INPUT VOLTAGE

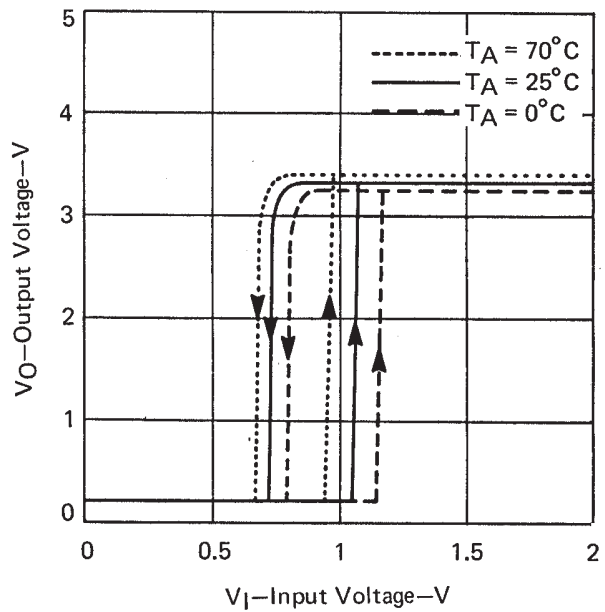

FIGURE 4

SN54LS641, SN54LS642, SN54LS644
SN74LS641, SN74LS642, SN74LS644
OCTAL BUS TRANSCEIVERS WITH OPEN-COLLECTOR OUTPUTS

SDLS189 – APRIL 1979 – REVISED MARCH 1988

absolute maximum ratings over operating free-air temperature range (unless otherwise noted)

Supply voltage, V_{CC} (see Note 1)	7 V
Input voltage: All inputs and I/O ports	7 V
Operating free-air temperature range: SN54LS641, SN54LS642, SN54LS644	– 55° C to 125° C
SN74LS641, SN74LS642, SN74LS644	0° C to 70° C
Storage temperature range	– 65° C to 150° C

NOTE 1: Voltage values are with respect to network ground terminal.

recommended operating conditions

PARAMETER	SN54LS641 SN54LS642 SN54LS644			SN74LS641 SN74LS642 SN74LS644			UNIT
	MIN	NOM	MAX	MIN	NOM	MAX	
	V_{CC} Supply voltage	4.5	5	5.5	4.75	5	
V_{IH} High-level input voltage	2			2			V
V_{IL} Low-level input voltage	0.5			0.6			V
V_{OH} High-level output voltage	5.5			5.5			V
I_{OL} Low-level output current	12			24			mA
				48 §			
T_A Operating free-air temperature	– 55		125	0		70	°C

§ The 48 mA limit applies for the SN74LS641-1, SN74LS642-1, and SN74LS644-1 only.

electrical characteristics over recommended operating free-air temperature range (unless otherwise noted)

PARAMETER	TEST CONDITIONS †	SN54LS641 SN54LS642 SN54LS644			SN74LS641 SN74LS642 SN74LS644			UNIT
		MIN	TYP ‡	MAX	MIN	TYP ‡	MAX	
		V_{IK}	$V_{CC} = \text{MIN}, I_I = -18 \text{ mA}$	– 1.5			– 1.5	
Hysteresis ($V_{T+} - V_{T-}$)	$V_{CC} = \text{MIN}, A \text{ or } B \text{ input}$	0.1	0.4		0.2	0.4		V
I_{OH}	$V_{CC} = \text{MIN}, V_{IH} = 2 \text{ V}, V_{IL} = \text{MAX}, V_{OH} = 5.5 \text{ V}$	0.1			0.1			mA
V_{OL}	$V_{CC} = \text{MIN}, V_{IH} = 2 \text{ V}, V_{IL} = \text{MAX}$	$I_{OL} = 12 \text{ mA}$	0.25	0.4	0.25	0.4	V	
		$I_{OL} = 24 \text{ mA}$				0.35		0.5
		$I_{OL} = 48 \text{ mA} §$				0.4		0.5
I_I	A or B	$V_{CC} = \text{MAX}$	$V_I = 5.5 \text{ V}$	0.1			0.1	mA
	DIR or \bar{G}		$V_I = 7 \text{ V}$	0.1			0.1	
I_{IH}	$V_{CC} = \text{MAX}, V_I = 2.7 \text{ V}$	20			20			µA
I_{IL}	$V_{CC} = \text{MAX}, V_I = 0.4 \text{ V}$	– 0.4			– 0.4			mA
I_{CC}	Outputs high	$V_{CC} = \text{MAX},$ Outputs open	48	70	48	70	mA	
	Outputs low		62	90	62	90		
	Outputs at Hi-Z		64	95	64	95		

† For conditions shown as MIN or MAX, use the appropriate value specified under recommended operating conditions.

‡ All typical values are at $V_{CC} = 5 \text{ V}, T_A = 25^\circ \text{C}$.

§ The 48 mA condition applies for the SN74LS641-1, SN74LS642-1, and SN74LS644-1 only.



SN54LS641, SN54LS642, SN54LS644
 SN74LS641, SN74LS642, SN74LS644
 OCTAL BUS TRANSCEIVERS WITH OPEN-COLLECTOR OUTPUTS

SDLS189 – APRIL 1979 – REVISED MARCH 1988

switching characteristics at $V_{CC} = 5\text{ V}$, $T_A = 25^\circ\text{C}$

PARAMETER	FROM (INPUT)	TO (OUTPUT)	'LS641, 'LS641-1		'LS642, 'LS642-1		'LS644, 'LS644-1		UNIT
			MIN	TYP	MAX	MIN	TYP	MAX	
t _{PLH} Propagation delay time, low-to-high-level output	A	B	17	25	19	25	17	25	ns
	B	A	17	25	19	25	19	25	
t _{PHL} Propagation delay time, high-to-low-level output	A	B	16	25	14	25	14	25	ns
	B	A	16	25	14	25	16	25	
t _{PLH} Output disable time from low level	\bar{G} , DIR	A	23	40	26	40	26	40	ns
	\bar{G} , DIR	B	25	40	28	40	25	40	
t _{PHL} Output enable time from high level	\bar{G} , DIR	A	34	50	43	60	43	60	ns
	\bar{G} , DIR	B	37	50	39	60	37	50	

TEST CONDITIONS
 $C_L = 45\text{ pF}$,
 $R_L = 667\ \Omega$,
 See Note 2

NOTE 2: Load circuits and voltage waveforms are shown in Section 1.

schematics of inputs and outputs

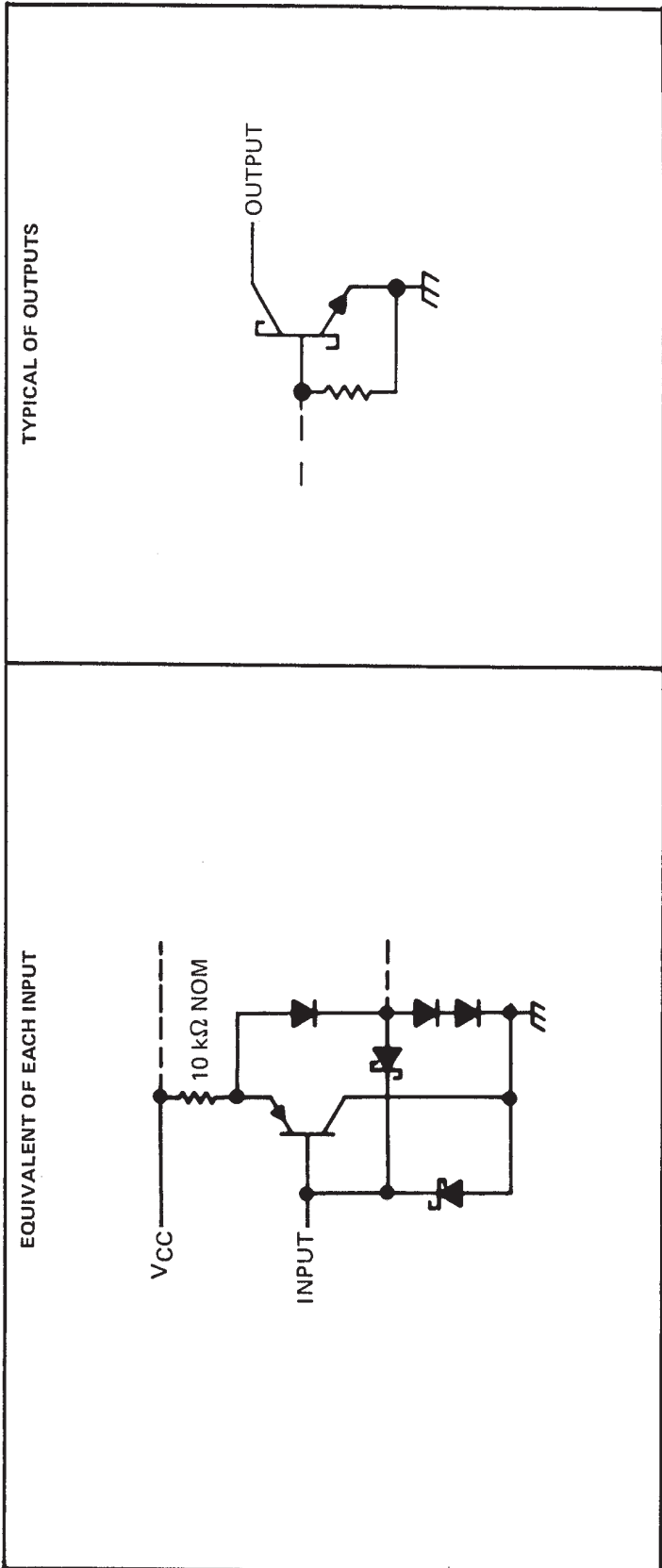

PACKAGING INFORMATION

Orderable Device	Status (1)	Package Type	Package Drawing	Pins	Package Qty	Eco Plan (2)	Lead finish/ Ball material (6)	MSL Peak Temp (3)	Op Temp (°C)	Device Marking (4/5)	Samples
84161012A	ACTIVE	LCCC	FK	20	1	Non-RoHS & Green	SNPB	N / A for Pkg Type	-55 to 125	84161012A SNJ54LS 640FK	Samples
8416101RA	ACTIVE	CDIP	J	20	1	Non-RoHS & Green	SNPB	N / A for Pkg Type	-55 to 125	8416101RA SNJ54LS640J	Samples
SN54LS640J	ACTIVE	CDIP	J	20	1	Non-RoHS & Green	SNPB	N / A for Pkg Type	-55 to 125	SN54LS640J	Samples
SN54LS645J	ACTIVE	CDIP	J	20	1	Non-RoHS & Green	SNPB	N / A for Pkg Type	-55 to 125	SN54LS645J	Samples
SN74LS640-1DW	ACTIVE	SOIC	DW	20	25	RoHS & Green	NIPDAU	Level-1-260C-UNLIM	0 to 70	LS640-1	Samples
SN74LS640-1N	ACTIVE	PDIP	N	20	20	RoHS & Non-Green	NIPDAU	N / A for Pkg Type	0 to 70	SN74LS640-1N	Samples
SN74LS640-1NSR	ACTIVE	SO	NS	20	2000	RoHS & Green	NIPDAU	Level-1-260C-UNLIM	0 to 70	74LS640-1	Samples
SN74LS640DW	ACTIVE	SOIC	DW	20	25	RoHS & Green	NIPDAU	Level-1-260C-UNLIM	0 to 70	LS640	Samples
SN74LS640DWR	ACTIVE	SOIC	DW	20	2000	RoHS & Green	NIPDAU	Level-1-260C-UNLIM	0 to 70	LS640	Samples
SN74LS640N	ACTIVE	PDIP	N	20	20	RoHS & Non-Green	NIPDAU	N / A for Pkg Type	0 to 70	SN74LS640N	Samples
SN74LS640NSR	ACTIVE	SO	NS	20	2000	RoHS & Green	NIPDAU	Level-1-260C-UNLIM	0 to 70	74LS640	Samples
SN74LS641-1DW	ACTIVE	SOIC	DW	20	25	RoHS & Green	NIPDAU	Level-1-260C-UNLIM	0 to 70	LS641-1	Samples
SN74LS641-1DWR	ACTIVE	SOIC	DW	20	2000	RoHS & Green	NIPDAU	Level-1-260C-UNLIM	0 to 70	LS641-1	Samples
SN74LS641-1N	ACTIVE	PDIP	N	20	20	RoHS & Non-Green	NIPDAU	N / A for Pkg Type	0 to 70	SN74LS641-1N	Samples
SN74LS641DW	ACTIVE	SOIC	DW	20	25	RoHS & Green	NIPDAU	Level-1-260C-UNLIM	0 to 70	LS641	Samples
SN74LS641N	ACTIVE	PDIP	N	20	20	RoHS & Non-Green	NIPDAU	N / A for Pkg Type	0 to 70	SN74LS641N	Samples
SN74LS641NSR	ACTIVE	SO	NS	20	2000	RoHS & Green	NIPDAU	Level-1-260C-UNLIM	0 to 70	74LS641	Samples
SN74LS642-1DW	ACTIVE	SOIC	DW	20	25	RoHS & Green	NIPDAU	Level-1-260C-UNLIM	0 to 70	LS642-1	Samples

Orderable Device	Status (1)	Package Type	Package Drawing	Pins	Package Qty	Eco Plan (2)	Lead finish/ Ball material (6)	MSL Peak Temp (3)	Op Temp (°C)	Device Marking (4/5)	Samples
SN74LS642-1N	ACTIVE	PDIP	N	20	20	RoHS & Non-Green	NIPDAU	N / A for Pkg Type	0 to 70	SN74LS642-1N	Samples
SN74LS642DW	ACTIVE	SOIC	DW	20	25	RoHS & Green	NIPDAU	Level-1-260C-UNLIM	0 to 70	LS642	Samples
SN74LS642N	ACTIVE	PDIP	N	20	20	RoHS & Non-Green	NIPDAU	N / A for Pkg Type	0 to 70	SN74LS642N	Samples
SN74LS642NSR	ACTIVE	SO	NS	20	2000	RoHS & Green	NIPDAU	Level-1-260C-UNLIM	0 to 70	74LS642	Samples
SN74LS645-1DW	ACTIVE	SOIC	DW	20	25	RoHS & Green	NIPDAU	Level-1-260C-UNLIM	0 to 70	LS645-1	Samples
SN74LS645-1DWR	ACTIVE	SOIC	DW	20	2000	RoHS & Green	NIPDAU	Level-1-260C-UNLIM	0 to 70	LS645-1	Samples
SN74LS645-1N	ACTIVE	PDIP	N	20	20	RoHS & Non-Green	NIPDAU	N / A for Pkg Type	0 to 70	SN74LS645-1N	Samples
SN74LS645-1NSR	ACTIVE	SO	NS	20	2000	RoHS & Green	NIPDAU	Level-1-260C-UNLIM	0 to 70	74LS645-1	Samples
SN74LS645DW	ACTIVE	SOIC	DW	20	25	RoHS & Green	NIPDAU	Level-1-260C-UNLIM	0 to 70	LS645	Samples
SN74LS645N	ACTIVE	PDIP	N	20	20	RoHS & Non-Green	NIPDAU	N / A for Pkg Type	0 to 70	SN74LS645N	Samples
SN74LS645NSR	ACTIVE	SO	NS	20	2000	RoHS & Green	NIPDAU	Level-1-260C-UNLIM	0 to 70	74LS645	Samples
SNJ54LS640FK	ACTIVE	LCCC	FK	20	1	Non-RoHS & Green	SNPB	N / A for Pkg Type	-55 to 125	84161012A SNJ54LS 640FK	Samples
SNJ54LS640J	ACTIVE	CDIP	J	20	1	Non-RoHS & Green	SNPB	N / A for Pkg Type	-55 to 125	8416101RA SNJ54LS640J	Samples
SNJ54LS645J	ACTIVE	CDIP	J	20	1	Non-RoHS & Green	SNPB	N / A for Pkg Type	-55 to 125	SNJ54LS645J	Samples

(1) The marketing status values are defined as follows:

ACTIVE: Product device recommended for new designs.

LIFEBUY: TI has announced that the device will be discontinued, and a lifetime-buy period is in effect.

NRND: Not recommended for new designs. Device is in production to support existing customers, but TI does not recommend using this part in a new design.

PREVIEW: Device has been announced but is not in production. Samples may or may not be available.

OBSOLETE: TI has discontinued the production of the device.

(2) **RoHS:** TI defines "RoHS" to mean semiconductor products that are compliant with the current EU RoHS requirements for all 10 RoHS substances, including the requirement that RoHS substance do not exceed 0.1% by weight in homogeneous materials. Where designed to be soldered at high temperatures, "RoHS" products are suitable for use in specified lead-free processes. TI may reference these types of products as "Pb-Free".

RoHS Exempt: TI defines "RoHS Exempt" to mean products that contain lead but are compliant with EU RoHS pursuant to a specific EU RoHS exemption.

Green: TI defines "Green" to mean the content of Chlorine (Cl) and Bromine (Br) based flame retardants meet JS709B low halogen requirements of ≤ 1000 ppm threshold. Antimony trioxide based flame retardants must also meet the ≤ 1000 ppm threshold requirement.

(3) MSL, Peak Temp. - The Moisture Sensitivity Level rating according to the JEDEC industry standard classifications, and peak solder temperature.

(4) There may be additional marking, which relates to the logo, the lot trace code information, or the environmental category on the device.

(5) Multiple Device Markings will be inside parentheses. Only one Device Marking contained in parentheses and separated by a "~" will appear on a device. If a line is indented then it is a continuation of the previous line and the two combined represent the entire Device Marking for that device.

(6) Lead finish/Ball material - Orderable Devices may have multiple material finish options. Finish options are separated by a vertical ruled line. Lead finish/Ball material values may wrap to two lines if the finish value exceeds the maximum column width.

Important Information and Disclaimer: The information provided on this page represents TI's knowledge and belief as of the date that it is provided. TI bases its knowledge and belief on information provided by third parties, and makes no representation or warranty as to the accuracy of such information. Efforts are underway to better integrate information from third parties. TI has taken and continues to take reasonable steps to provide representative and accurate information but may not have conducted destructive testing or chemical analysis on incoming materials and chemicals. TI and TI suppliers consider certain information to be proprietary, and thus CAS numbers and other limited information may not be available for release.

In no event shall TI's liability arising out of such information exceed the total purchase price of the TI part(s) at issue in this document sold by TI to Customer on an annual basis.

OTHER QUALIFIED VERSIONS OF SN54LS640, SN54LS645, SN74LS640, SN74LS645 :

● Catalog : [SN74LS640](#), [SN74LS645](#)

● Military : [SN54LS640](#), [SN54LS645](#)

NOTE: Qualified Version Definitions:

● Catalog - TI's standard catalog product

● Military - QML certified for Military and Defense Applications

TAPE AND REEL INFORMATION

QUADRANT ASSIGNMENTS FOR PIN 1 ORIENTATION IN TAPE



*All dimensions are nominal

Device	Package Type	Package Drawing	Pins	SPQ	Reel Diameter (mm)	Reel Width W1 (mm)	A0 (mm)	B0 (mm)	K0 (mm)	P1 (mm)	W (mm)	Pin1 Quadrant
SN74LS640-1NSR	SO	NS	20	2000	330.0	24.4	8.4	13.0	2.5	12.0	24.0	Q1
SN74LS640DWR	SOIC	DW	20	2000	330.0	24.4	10.8	13.3	2.7	12.0	24.0	Q1
SN74LS640NSR	SO	NS	20	2000	330.0	24.4	8.4	13.0	2.5	12.0	24.0	Q1
SN74LS641-1DWR	SOIC	DW	20	2000	330.0	24.4	10.8	13.3	2.7	12.0	24.0	Q1
SN74LS641NSR	SO	NS	20	2000	330.0	24.4	8.4	13.0	2.5	12.0	24.0	Q1
SN74LS642NSR	SO	NS	20	2000	330.0	24.4	8.4	13.0	2.5	12.0	24.0	Q1
SN74LS645-1DWR	SOIC	DW	20	2000	330.0	24.4	10.8	13.3	2.7	12.0	24.0	Q1
SN74LS645-1NSR	SO	NS	20	2000	330.0	24.4	8.4	13.0	2.5	12.0	24.0	Q1
SN74LS645NSR	SO	NS	20	2000	330.0	24.4	8.4	13.0	2.5	12.0	24.0	Q1

TAPE AND REEL BOX DIMENSIONS

*All dimensions are nominal

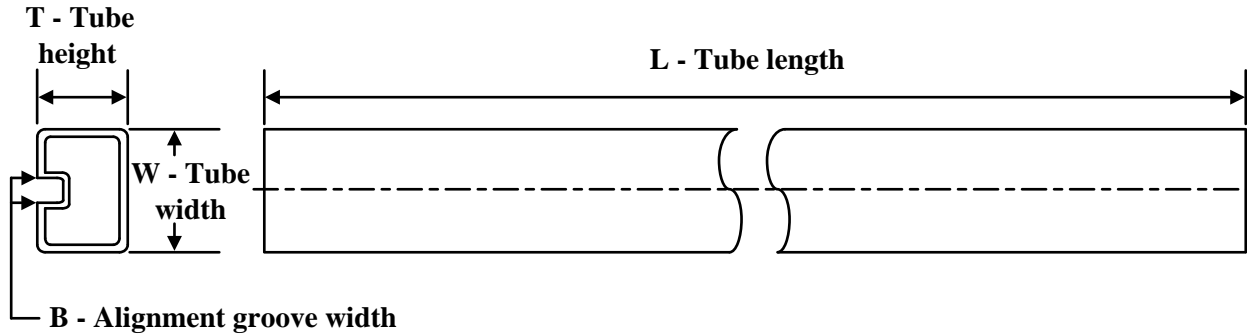
Device	Package Type	Package Drawing	Pins	SPQ	Length (mm)	Width (mm)	Height (mm)
SN74LS640-1NSR	SO	NS	20	2000	367.0	367.0	45.0
SN74LS640DWR	SOIC	DW	20	2000	367.0	367.0	45.0
SN74LS640NSR	SO	NS	20	2000	367.0	367.0	45.0
SN74LS641-1DWR	SOIC	DW	20	2000	367.0	367.0	45.0
SN74LS641NSR	SO	NS	20	2000	367.0	367.0	45.0
SN74LS642NSR	SO	NS	20	2000	367.0	367.0	45.0
SN74LS645-1DWR	SOIC	DW	20	2000	367.0	367.0	45.0
SN74LS645-1NSR	SO	NS	20	2000	367.0	367.0	45.0
SN74LS645NSR	SO	NS	20	2000	367.0	367.0	45.0

TUBE

*All dimensions are nominal

Device	Package Name	Package Type	Pins	SPQ	L (mm)	W (mm)	T (μm)	B (mm)
84161012A	FK	LCCC	20	1	506.98	12.06	2030	NA
SN74LS640-1DW	DW	SOIC	20	25	507	12.83	5080	6.6
SN74LS640-1N	N	PDIP	20	20	506	13.97	11230	4.32
SN74LS640DW	DW	SOIC	20	25	507	12.83	5080	6.6
SN74LS640N	N	PDIP	20	20	506	13.97	11230	4.32
SN74LS641-1DW	DW	SOIC	20	25	507	12.83	5080	6.6
SN74LS641-1N	N	PDIP	20	20	506	13.97	11230	4.32
SN74LS641DW	DW	SOIC	20	25	507	12.83	5080	6.6
SN74LS641N	N	PDIP	20	20	506	13.97	11230	4.32
SN74LS642-1DW	DW	SOIC	20	25	507	12.83	5080	6.6
SN74LS642-1N	N	PDIP	20	20	506	13.97	11230	4.32
SN74LS642DW	DW	SOIC	20	25	507	12.83	5080	6.6
SN74LS642N	N	PDIP	20	20	506	13.97	11230	4.32
SN74LS645-1DW	DW	SOIC	20	25	507	12.83	5080	6.6
SN74LS645-1N	N	PDIP	20	20	506	13.97	11230	4.32
SN74LS645DW	DW	SOIC	20	25	507	12.83	5080	6.6
SN74LS645N	N	PDIP	20	20	506	13.97	11230	4.32
SNJ54LS640FK	FK	LCCC	20	1	506.98	12.06	2030	NA

MECHANICAL DATA

NS (R-PDSO-G**)

PLASTIC SMALL-OUTLINE PACKAGE

14-PINS SHOWN



- NOTES:
- A. All linear dimensions are in millimeters.
 - B. This drawing is subject to change without notice.
 - C. Body dimensions do not include mold flash or protrusion, not to exceed 0,15.

J (R-GDIP-T**)

14 LEADS SHOWN

CERAMIC DUAL IN-LINE PACKAGE



DIM \ PINS **	14	16	18	20
A	0.300 (7,62) BSC	0.300 (7,62) BSC	0.300 (7,62) BSC	0.300 (7,62) BSC
B MAX	0.785 (19,94)	.840 (21,34)	0.960 (24,38)	1.060 (26,92)
B MIN	—	—	—	—
C MAX	0.300 (7,62)	0.300 (7,62)	0.310 (7,87)	0.300 (7,62)
C MIN	0.245 (6,22)	0.245 (6,22)	0.220 (5,59)	0.245 (6,22)



4040083/F 03/03

- NOTES:
- All linear dimensions are in inches (millimeters).
 - This drawing is subject to change without notice.
 - This package is hermetically sealed with a ceramic lid using glass frit.
 - Index point is provided on cap for terminal identification only on press ceramic glass frit seal only.
 - Falls within MIL STD 1835 GDIP1-T14, GDIP1-T16, GDIP1-T18 and GDIP1-T20.

GENERIC PACKAGE VIEW

FK 20

LCCC - 2.03 mm max height

8.89 x 8.89, 1.27 mm pitch

LEADLESS CERAMIC CHIP CARRIER

This image is a representation of the package family, actual package may vary.
Refer to the product data sheet for package details.

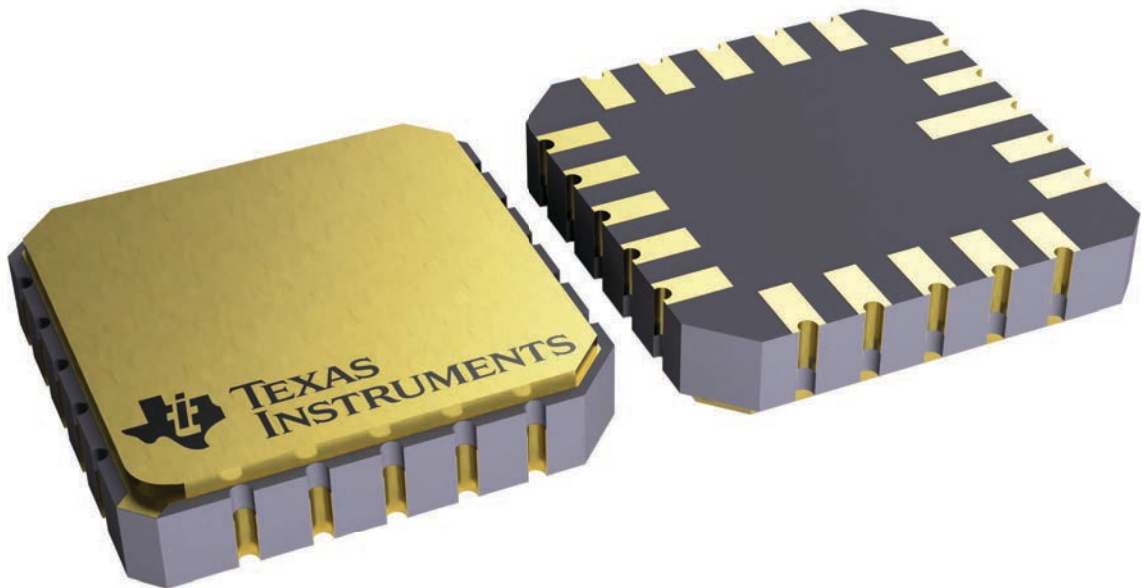

4229370VA\

N (R-PDIP-T**)

PLASTIC DUAL-IN-LINE PACKAGE

16 PINS SHOWN



- NOTES:
- A. All linear dimensions are in inches (millimeters).
 - B. This drawing is subject to change without notice.
 - Falls within JEDEC MS-001, except 18 and 20 pin minimum body length (Dim A).
 - The 20 pin end lead shoulder width is a vendor option, either half or full width.

DW0020A



PACKAGE OUTLINE

SOIC - 2.65 mm max height

SOIC



4220724/A 05/2016

NOTES:

- All linear dimensions are in millimeters. Dimensions in parenthesis are for reference only. Dimensioning and tolerancing per ASME Y14.5M.
- This drawing is subject to change without notice.
- This dimension does not include mold flash, protrusions, or gate burrs. Mold flash, protrusions, or gate burrs shall not exceed 0.15 mm per side.
- This dimension does not include interlead flash. Interlead flash shall not exceed 0.43 mm per side.
- Reference JEDEC registration MS-013.

EXAMPLE BOARD LAYOUT

DW0020A

SOIC - 2.65 mm max height

SOIC



LAND PATTERN EXAMPLE
SCALE:6X



SOLDER MASK DETAILS

4220724/A 05/2016

NOTES: (continued)

- 6. Publication IPC-7351 may have alternate designs.
- 7. Solder mask tolerances between and around signal pads can vary based on board fabrication site.

EXAMPLE STENCIL DESIGN

DW0020A

SOIC - 2.65 mm max height

SOIC



SOLDER PASTE EXAMPLE
BASED ON 0.125 mm THICK STENCIL
SCALE:6X

4220724/A 05/2016

NOTES: (continued)

8. Laser cutting apertures with trapezoidal walls and rounded corners may offer better paste release. IPC-7525 may have alternate design recommendations.
9. Board assembly site may have different recommendations for stencil design.

IMPORTANT NOTICE AND DISCLAIMER

TI PROVIDES TECHNICAL AND RELIABILITY DATA (INCLUDING DATA SHEETS), DESIGN RESOURCES (INCLUDING REFERENCE DESIGNS), APPLICATION OR OTHER DESIGN ADVICE, WEB TOOLS, SAFETY INFORMATION, AND OTHER RESOURCES "AS IS" AND WITH ALL FAULTS, AND DISCLAIMS ALL WARRANTIES, EXPRESS AND IMPLIED, INCLUDING WITHOUT LIMITATION ANY IMPLIED WARRANTIES OF MERCHANTABILITY, FITNESS FOR A PARTICULAR PURPOSE OR NON-INFRINGEMENT OF THIRD PARTY INTELLECTUAL PROPERTY RIGHTS.

These resources are intended for skilled developers designing with TI products. You are solely responsible for (1) selecting the appropriate TI products for your application, (2) designing, validating and testing your application, and (3) ensuring your application meets applicable standards, and any other safety, security, regulatory or other requirements.

These resources are subject to change without notice. TI grants you permission to use these resources only for development of an application that uses the TI products described in the resource. Other reproduction and display of these resources is prohibited. No license is granted to any other TI intellectual property right or to any third party intellectual property right. TI disclaims responsibility for, and you will fully indemnify TI and its representatives against, any claims, damages, costs, losses, and liabilities arising out of your use of these resources.

TI's products are provided subject to [TI's Terms of Sale](#) or other applicable terms available either on [ti.com](https://www.ti.com) or provided in conjunction with such TI products. TI's provision of these resources does not expand or otherwise alter TI's applicable warranties or warranty disclaimers for TI products.

TI objects to and rejects any additional or different terms you may have proposed.

Mailing Address: Texas Instruments, Post Office Box 655303, Dallas, Texas 75265
Copyright © 2023, Texas Instruments Incorporated