

CCD VERTICAL DRIVER FOR DIGITAL CAMERAS

FEATURES

- **CCD Vertical Driver:**
 - Three Field CCD Support
 - Two Field CCD Support
- **Output Drivers:**
 - 3 Levels Driver (V-Transfer) x 5
 - 2 Levels Driver (V-Transfer) x 3
 - 2 Levels Driver (E-Shutter) x 1
- **Drive Capability:**
 - 450 pF to 1890 pF With 60 Ω to 240 Ω
- **Input Phase:**
 - 3 State (V-Transfer) x 5
 - 2 State (V-Transfer) x 3
 - 2 State (E-Shutter) x 1
- **Portable Operation:**
 - Input Interface: 2.7 V to 5.5 V

- **Power Supply:**
 - VDD 2.7 V to 5.5 V
 - VL –5 V to –9 V
 - VM GND
 - VH 11.5V to 15.5 V

APPLICATIONS

- Digital Camera
- Video Camera

DESCRIPTION

The VSP1900 is a CCD vertical clock driver with electric-shutter support. This device is composed of eight vertical transfer channels, which support both 3-field CCD and 2-field CCD operation. The VSP1900 contributes low power consumption and parts number reduction in the system.



Please be aware that an important notice concerning availability, standard warranty, and use in critical applications of Texas Instruments semiconductor products and disclaimers thereto appears at the end of this data sheet.



These devices have limited built-in ESD protection. The leads should be shorted together or the device placed in conductive foam during storage or handling to prevent electrostatic damage to the MOS gates.

ORDERING INFORMATION

PRODUCT	PACKAGE	PACKAGE DESIGNATOR	OPERATING TEMPERATURE RANGE	PACKAGE MARKING	ORDERING NUMBER	TRANSPORT MEDIA
VSP1900	TSSOP30	DBT	-25°C to 85°C	VSP1900	VSP1900	Tube (60 units/tube) Tape and reel

(1) For the most current specification and package information, refer to our web site at www.ti.com.

ABSOLUTE MAXIMUM RATINGS

over operating free-air temperature range unless otherwise noted⁽¹⁾

		UNITS
Supply voltage	VDD	GND -0.3 V to 7 V
	VL	GND to -10 V
	VH	VL + 26 V
Input voltage, V_{IN}		GND -0.3 V to (VDD + 0.3 V)
Ambient temperature under bias		-25°C to 85°C
Storage temperature, T_{stg}		-55°C to 150°C
Junction temperature		150°C
Package temperature (IR reflow, peak)		235°C

(1) Stresses beyond those listed under "absolute maximum ratings" may cause permanent damage to the device. These are stress ratings only, and functional operation of the device at these or any other conditions beyond those indicated under "recommended operating conditions" is not implied. Exposure to absolute-maximum-rated conditions for extended periods may affect device reliability.

RECOMMENDED OPERATING CONDITIONS

free-air temperature range unless otherwise noted

	MIN	NOM	MAX	UNIT
Supply voltage, VDD	2.7		5.5	V
Supply voltage, VL	-5		-9	V
Supply voltage, VH	11.5		15.5	V
Input voltage, V_{IN}	GND - 0.3 to (VDD + 0.3)			V

TRUTH TABLE

INPUT				OUTPUT		
V1N V3AN V3BN V5AN V5BN	CH1N CH2N CH3N CH4N CH5N	V2N V4N V6N	SUBN	V1 V3A V3B V5A V5B	V2 V4 V6	SUB
L	L	X	X	VH	X	X
L	H	X	X	VM	X	X
H	L	X	X	Z	X	X
H	H	X	X	VL	X	X
X	X	L	X	X	VM	X
X	X	H	X	X	VL	X
X	X	X	L	X	X	VH
X	X	X	H	X	X	VL

NOTE: Z = High impedance X = Don't care

ELECTRICAL CHARACTERISTICS

all specifications at $T_A = 25^\circ\text{C}$ (unless otherwise noted)

PARAMETER		TEST CONDITIONS	MIN	TYP	MAX	UNIT
DC power consumption				5.3		mW
Switching power consumption		VSP2267 (TG) with loading diagram		550		mW
DC CHARACTERISTICS						
V_{IH}	High-level input voltage		0.7VDD			V
V_{IL}	Low-level input voltage		0.2VDD			V
I_{IN}	Input current	$V_{IN} = \text{GND to } 5\text{ V (without pullup / pulldown resistor)}$	-10	0	10	μA
		$V_{IN} = \text{GND to } 5\text{ V (pullup / pulldown resistor)}$	-625	0	625	
I_H	Operating supply current		0.1		0.2	mA
I_{DD}			1			
I_L			0.125			
I_{OL}	Output current	$V_1, V_2, V_3A, V_3B, V_4, V_5A, V_5B, V_6 = -8.1\text{ V}$	10			mA
I_{OM1}		$V_1, V_2, V_3A, V_3B, V_4, V_5A, V_5B, V_6 = -0.2\text{ V}$			-5	
I_{OM2}		$V_1, V_3A, V_3B, V_5A, V_5B = 0.2\text{ V}$	5			
I_{OH}		$V_1, V_3A, V_3B, V_5A, V_5B = 14.55\text{ V}$			-7.2	
I_{OSL}		$\text{SUB} = -8.1\text{ V}$	5.4			
I_{OSH}		$\text{SUB} = 14.55\text{ V}$			-4	

SWITCHING CHARACTERISTICS

all specifications at $T_A = 25^\circ\text{C}$ (unless otherwise noted)

PARAMETER		TEST CONDITIONS	MIN	TYP	MAX	UNIT
$t_d(\text{PLM})$	Propagation delay time			15	100	ns
$t_d(\text{PMH})$				20	100	
$t_d(\text{PLH})$				20	100	
$t_d(\text{PML})$				15	50	
$t_d(\text{PHM})$				30	50	
$t_d(\text{PHL})$				30	50	
$t_r(\text{TLM})$	Rise time	$V_L \rightarrow V_M$			300	ns
$t_r(\text{TMH})$		$V_M \rightarrow V_H$			300	
$t_r(\text{TLH})$		$V_L \rightarrow V_H$			300	
$t_f(\text{TML})$	Fall time	$V_M \rightarrow V_L$			300	ns
$t_f(\text{THM})$		$V_H \rightarrow V_M$			300	
$t_f(\text{THL})$		$V_H \rightarrow V_L$			300	
$V_n(\text{CLH})$	Output noise voltage				2	V
$V_n(\text{CLL})$						
$V_n(\text{CMH})$						
$V_n(\text{CML})$						
$V_n(\text{CHL})$						

PIN ASSIGNMENTS

**DBT PACKAGE
(TOP VIEW)**

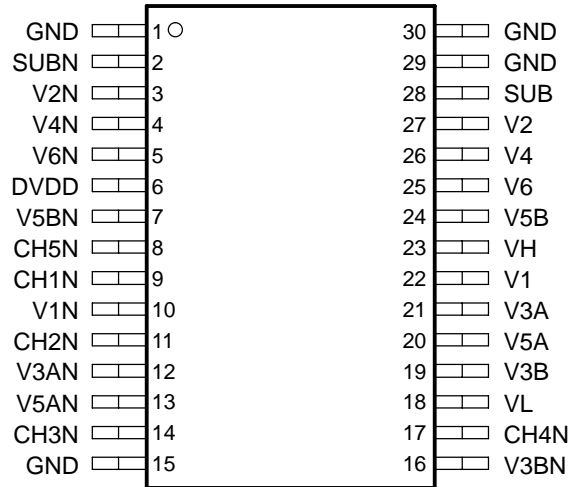

Terminal Functions

TERMINAL NAME	NO.	TYPE	DESCRIPTIONS
GND	1	P	Ground
SUBN	2	DI	CCD substrate clock SUB input
V2N	3	DI	Vertical transfer clock 2 input
V4N	4	DI	Vertical transfer clock 4 input
V6N	5	DI	Vertical transfer clock 6 input
DVDD	6	P	Digital power supply
V5BN	7	DI	Vertical transfer clock 5B input
CH5N	8	DI	Read out clock 5 input
CH1N	9	DI	Read out clock 1 input
V1N	10	DI	Vertical transfer clock 1 input
CH2N	11	DI	Read out clock 2 input
V3AN	12	DI	Vertical transfer clock 3A input
V5AN	13	DI	Vertical transfer clock 5A input
CH3N	14	DI	Read out clock 3 input
GND	15	P	Ground
V3BN	16	DI	Vertical transfer clock 3B input
CH4N	17	DI	Read out clock 4 input
VL	18	P	Digital power supply
V3B	19	DO	Vertical transfer clock 3B output
V5A	20	DO	Vertical transfer clock 5A output
V3A	21	DO	Vertical transfer clock 3A output
V1	22	DO	Vertical transfer clock 1 output
VH	23	P	Digital power supply
V5B	24	DO	Vertical transfer clock 5B output
V6	25	DO	Vertical transfer clock 6 output
V4	26	DO	Vertical transfer clock 4 output
V2	27	DO	Vertical transfer clock 2 output
SUB	28	DO	CCD substrate clock SUB output
GND	29	P	Ground
GND	30	P	Ground

FUNCTIONAL BLOCK DIAGRAM

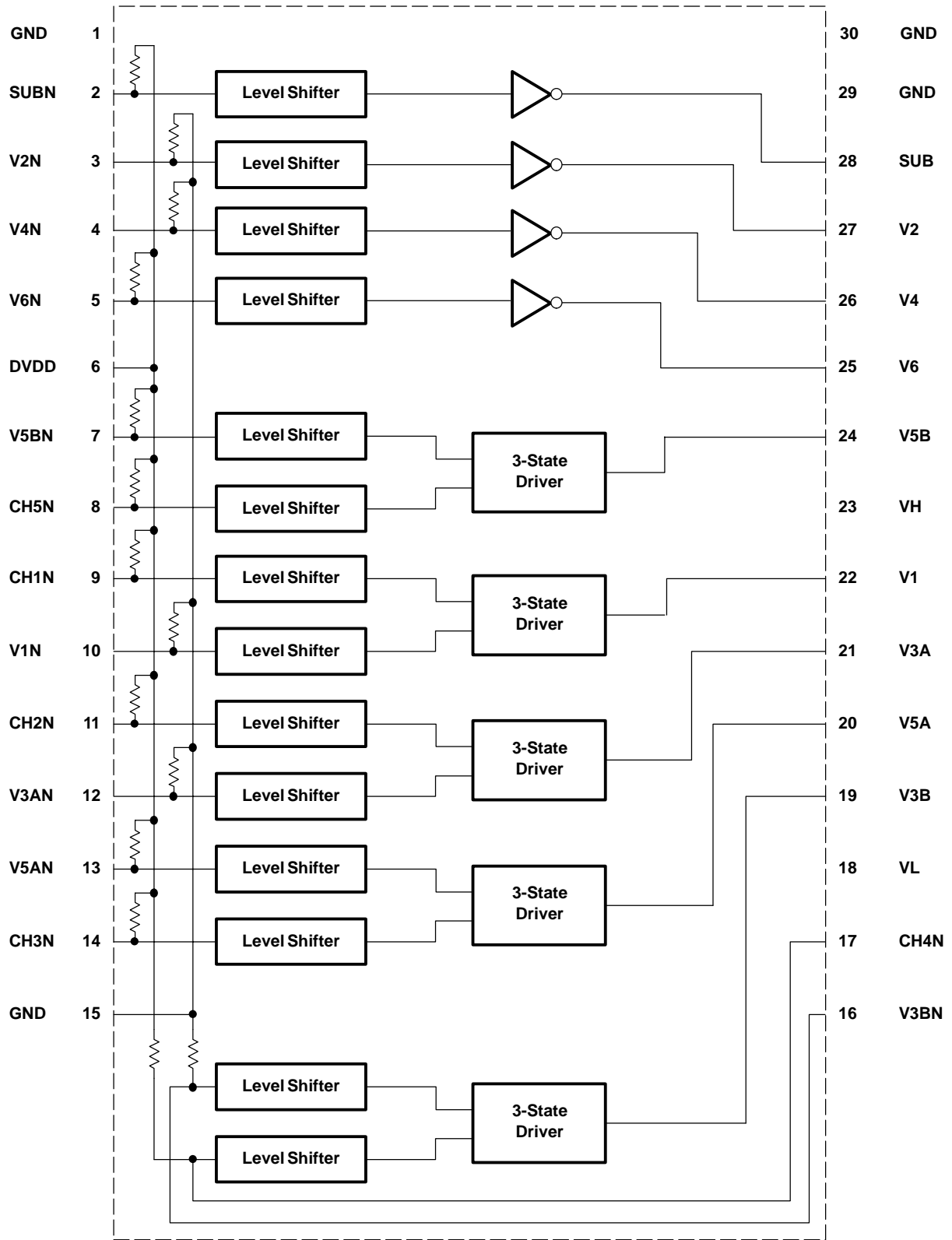

SWITCHING WAVEFORM

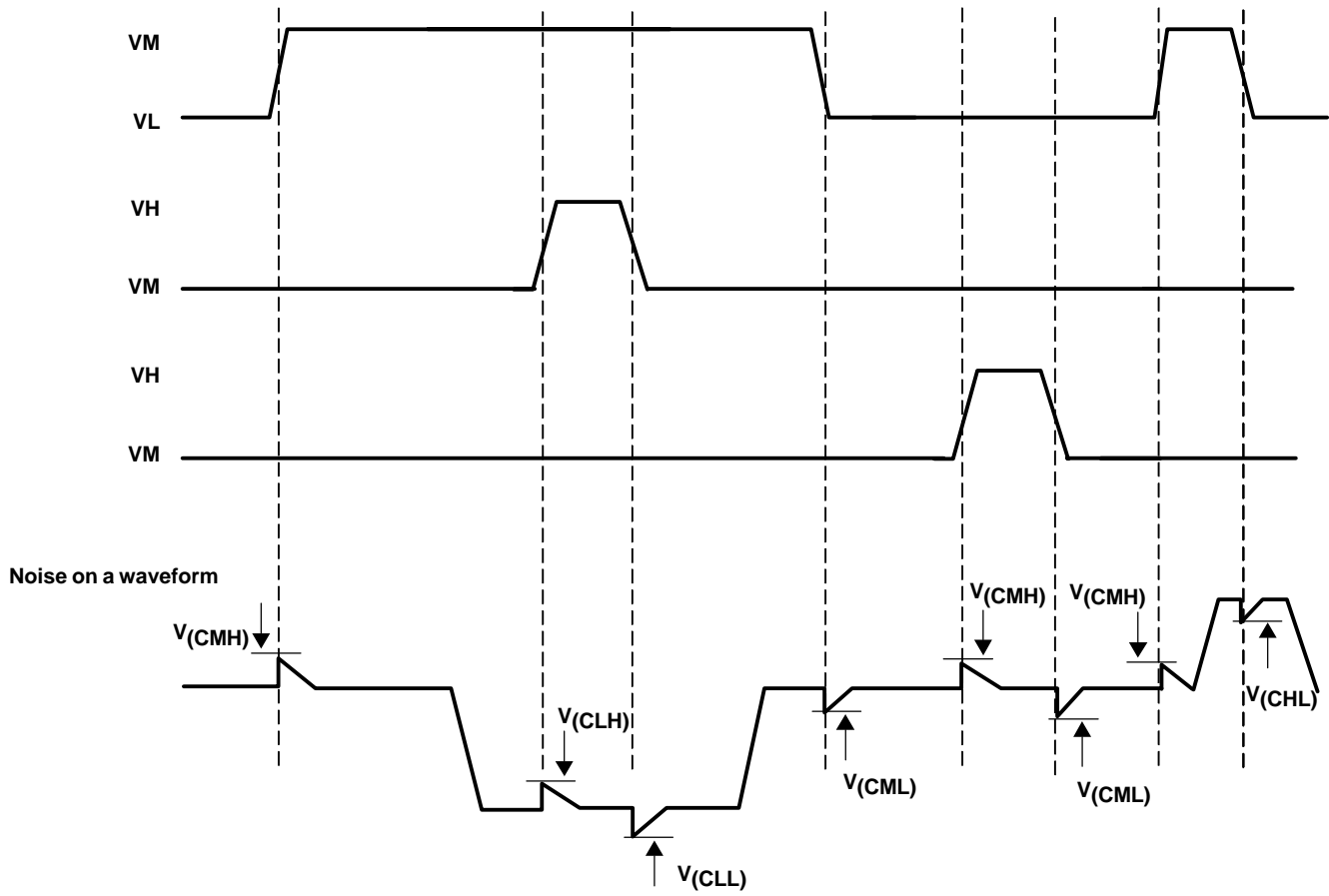

LOADING DIAGRAM

Vertical clock series resistor	R1, R2, R4, R6	60 Ω
	R3A, R5A	240 Ω
	R3B, R5B	80 Ω
Vertical clock to GND	CΦV1	1280 pF
	CΦV3A, CΦV3B	640 pF
	CΦV5A, CΦV5B	640 pF
	CΦV2, CΦV4, CΦV6	400 pF
Between vertical clock	CΦV12	510 pF
	CΦV23A, CΦV23B	50 pF
	CΦV45A, CΦV45B	50 pF
	CΦV3A4, CΦV3B4	260 pF
	CΦV5A6, CΦV5B6	260 pF
	CΦV61	100 pF
Substrate clock to GND	CΦVSUB	1000 pF
Vertical clock GND resistor	R GND	18 Ω

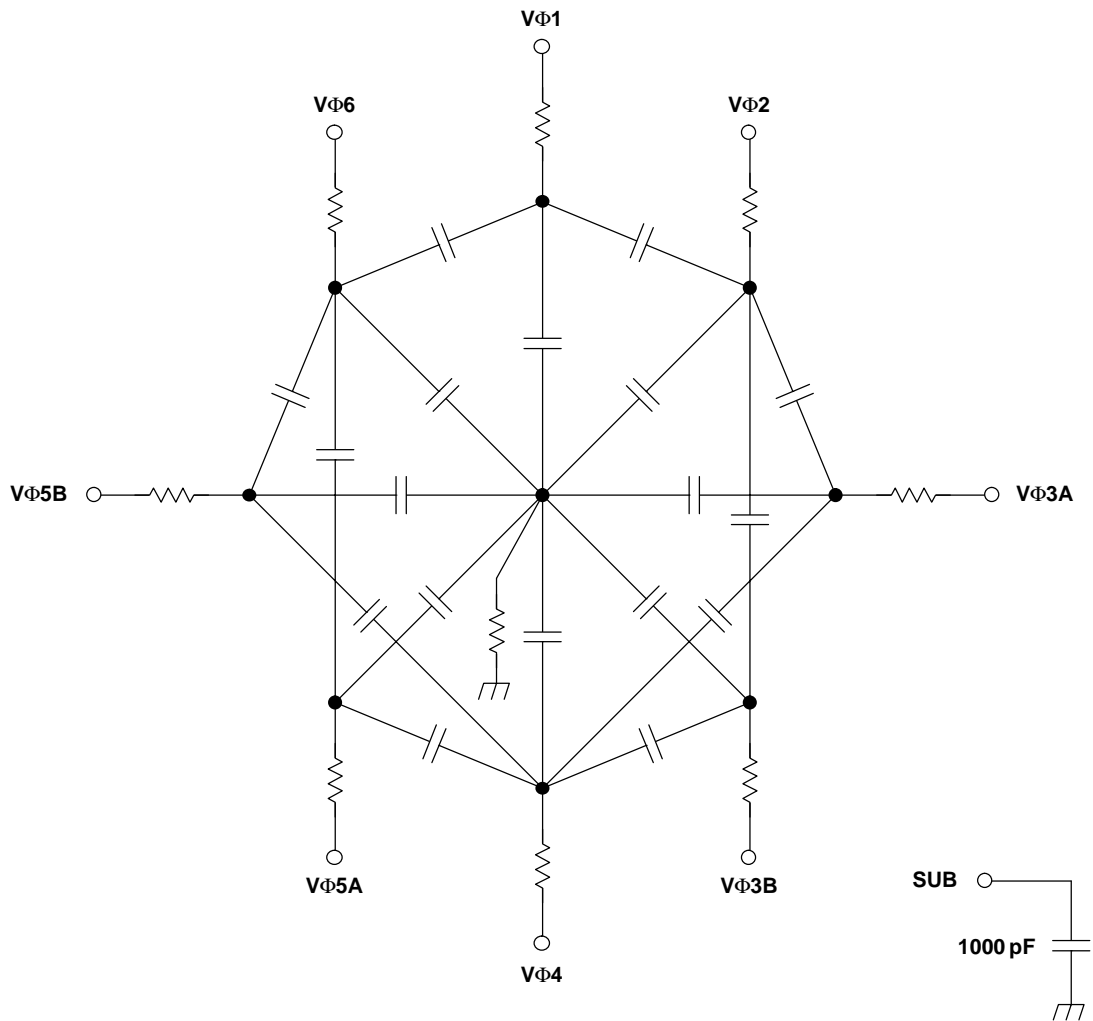

Figure 1. VSP1900 Loading Diagram

DESCRIPTION

The VSP1900 is a CCD vertical clock driver with electric shutter. The VSP1900 is composed of five 3-state and three 2-state vertical transfer channels, which support both 3 field and 2 field CCD operation. The VSP1900 contributes low power consumption and parts number reduction in the system.

OPERATION

Power On/Off Sequence

This is the same as the CCD power up sequence, when power on, VDD powers on first, VH, VM power on second, and VL powers on later. When powering off, VL powers off first, VH, VM power of second, and VDD powers off later.

Vertical Transfer Signal

The VSP1900 receives signals from TG (CCD timing generator). The input signal is converted into CCD operation voltage level by the level shifter. The level shifter circuits connect to a 2-state or 3-state driver, which is connected to the CCD input pin. While using a 2-field CCD, one of the 3-state drivers is used as a 2-state driver. The CH#N pin is pulled up internally, so that the VH level does not appear on the output pin.

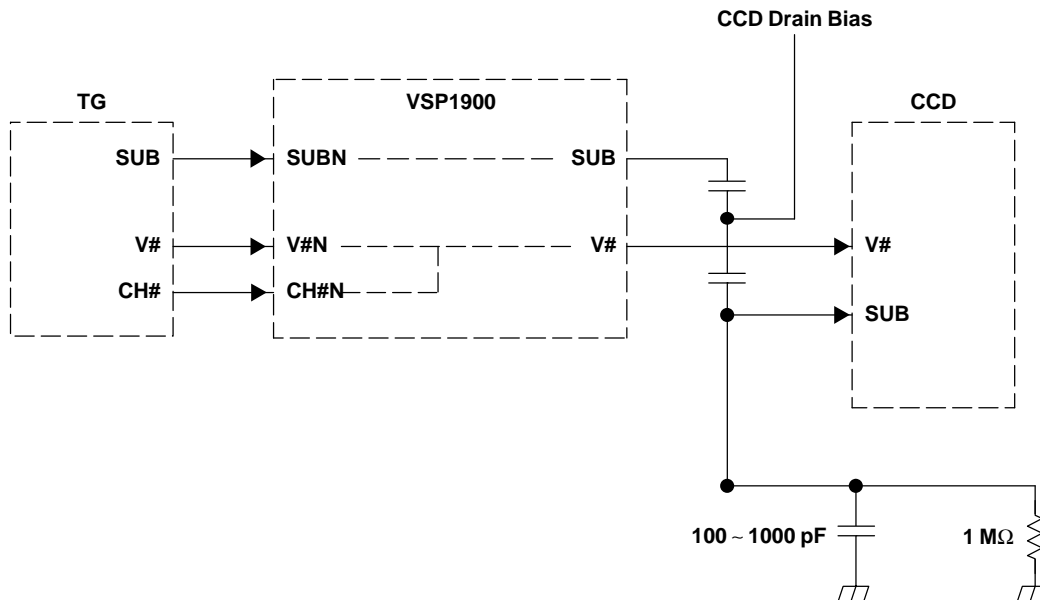

Figure 2. FVSP1900 Circuit Application

MECHANICAL DATA

DBT (R-PDSO-G)**

PLASTIC SMALL-OUTLINE PACKAGE

30 PINS SHOWN

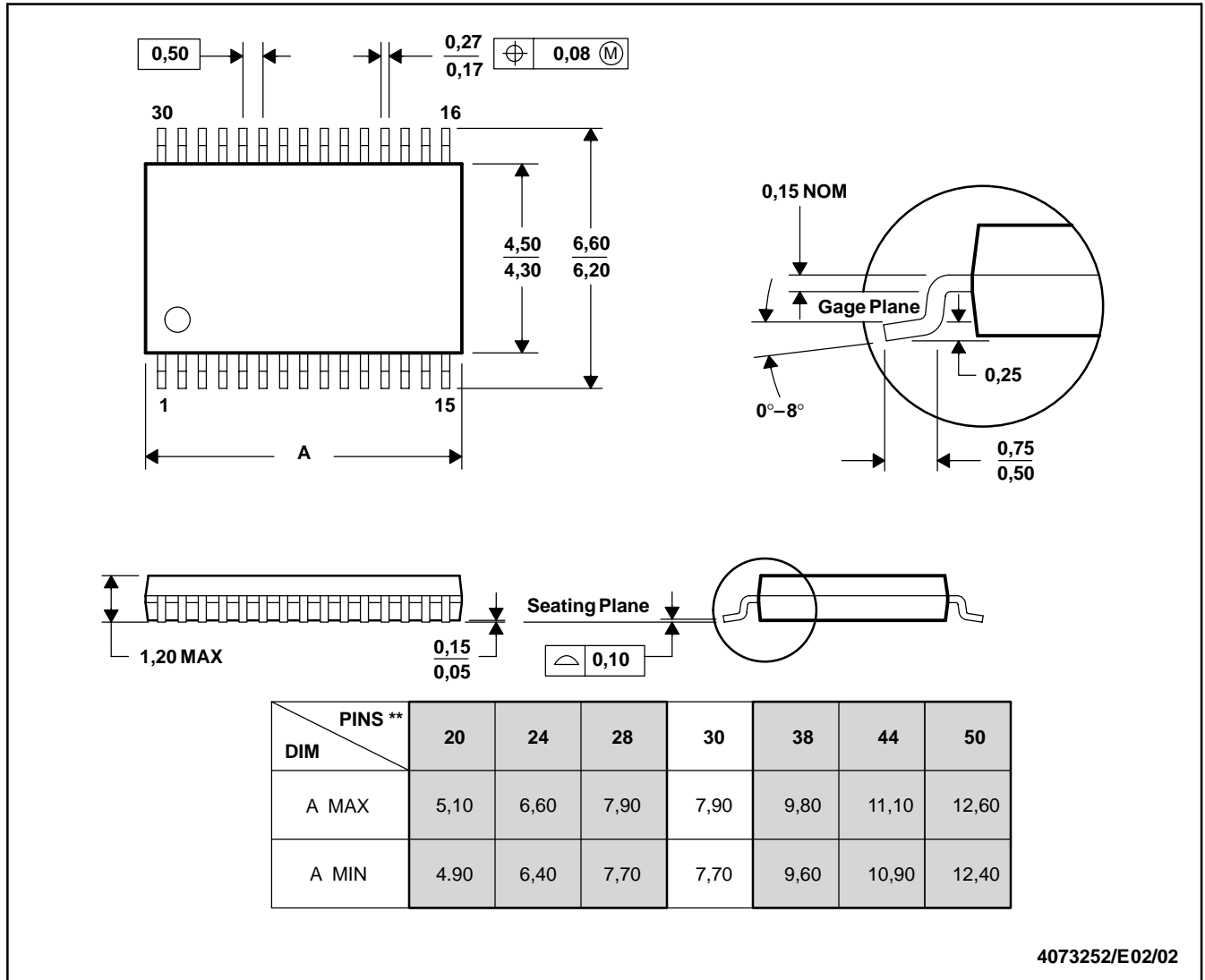

- NOTES: A. All linear dimensions are in millimeters.
 B. This drawing is subject to change without notice.
 C. Body dimensions do not include mold flash or protrusion.
 D. Falls within JEDEC MO-153

DBT (R-PDSO-G**)

PLASTIC SMALL-OUTLINE PACKAGE

30 PINS SHOWN

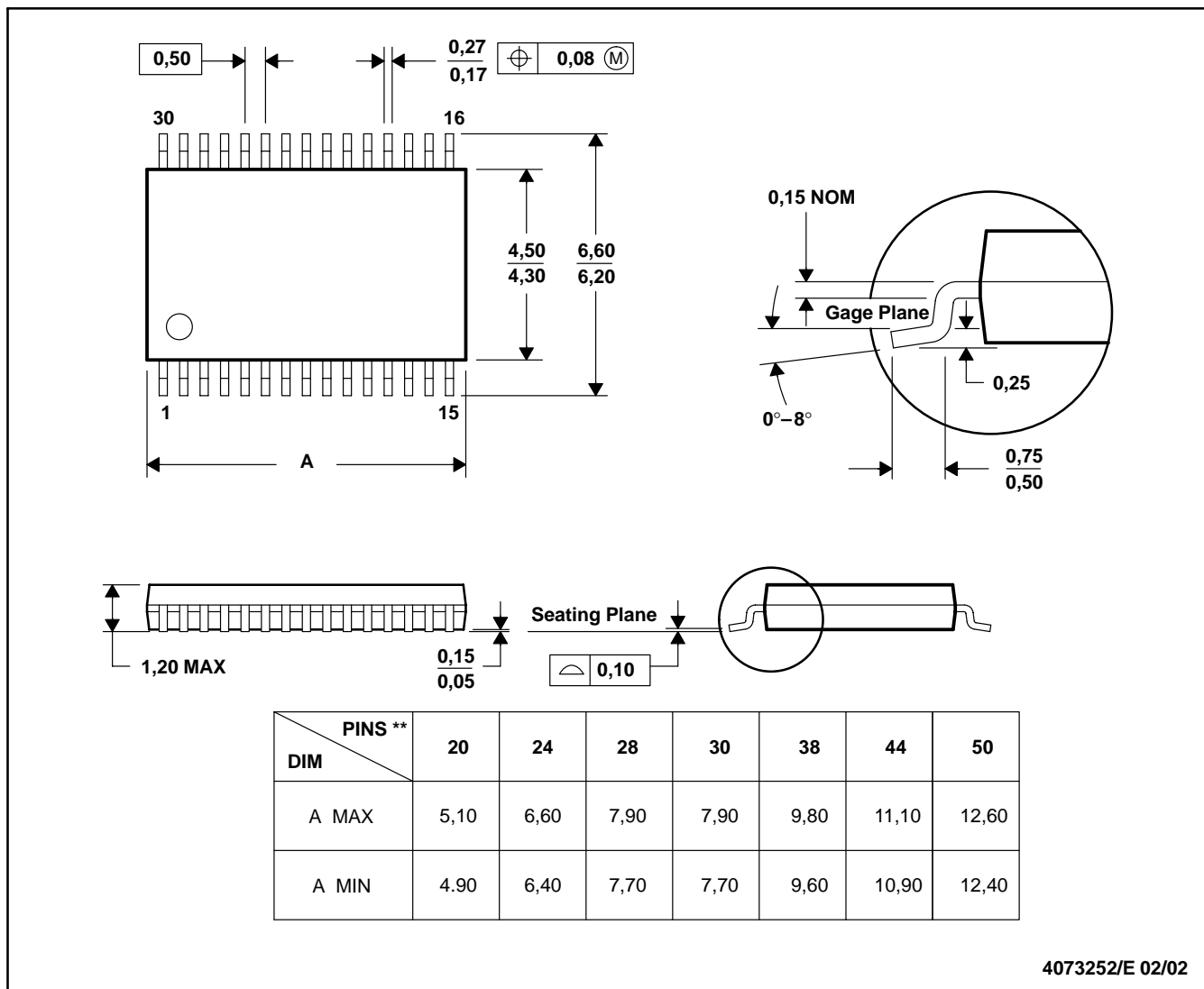

4073252/E 02/02

- NOTES: A. All linear dimensions are in millimeters.
 B. This drawing is subject to change without notice.
 C. Body dimensions do not include mold flash or protrusion.
 D. Falls within JEDEC MO-153

IMPORTANT NOTICE

Texas Instruments Incorporated and its subsidiaries (TI) reserve the right to make corrections, modifications, enhancements, improvements, and other changes to its products and services at any time and to discontinue any product or service without notice. Customers should obtain the latest relevant information before placing orders and should verify that such information is current and complete. All products are sold subject to TI's terms and conditions of sale supplied at the time of order acknowledgment.

TI warrants performance of its hardware products to the specifications applicable at the time of sale in accordance with TI's standard warranty. Testing and other quality control techniques are used to the extent TI deems necessary to support this warranty. Except where mandated by government requirements, testing of all parameters of each product is not necessarily performed.

TI assumes no liability for applications assistance or customer product design. Customers are responsible for their products and applications using TI components. To minimize the risks associated with customer products and applications, customers should provide adequate design and operating safeguards.

TI does not warrant or represent that any license, either express or implied, is granted under any TI patent right, copyright, mask work right, or other TI intellectual property right relating to any combination, machine, or process in which TI products or services are used. Information published by TI regarding third-party products or services does not constitute a license from TI to use such products or services or a warranty or endorsement thereof. Use of such information may require a license from a third party under the patents or other intellectual property of the third party, or a license from TI under the patents or other intellectual property of TI.

Reproduction of information in TI data books or data sheets is permissible only if reproduction is without alteration and is accompanied by all associated warranties, conditions, limitations, and notices. Reproduction of this information with alteration is an unfair and deceptive business practice. TI is not responsible or liable for such altered documentation.

Resale of TI products or services with statements different from or beyond the parameters stated by TI for that product or service voids all express and any implied warranties for the associated TI product or service and is an unfair and deceptive business practice. TI is not responsible or liable for any such statements.

Mailing Address:

Texas Instruments
Post Office Box 655303
Dallas, Texas 75265